

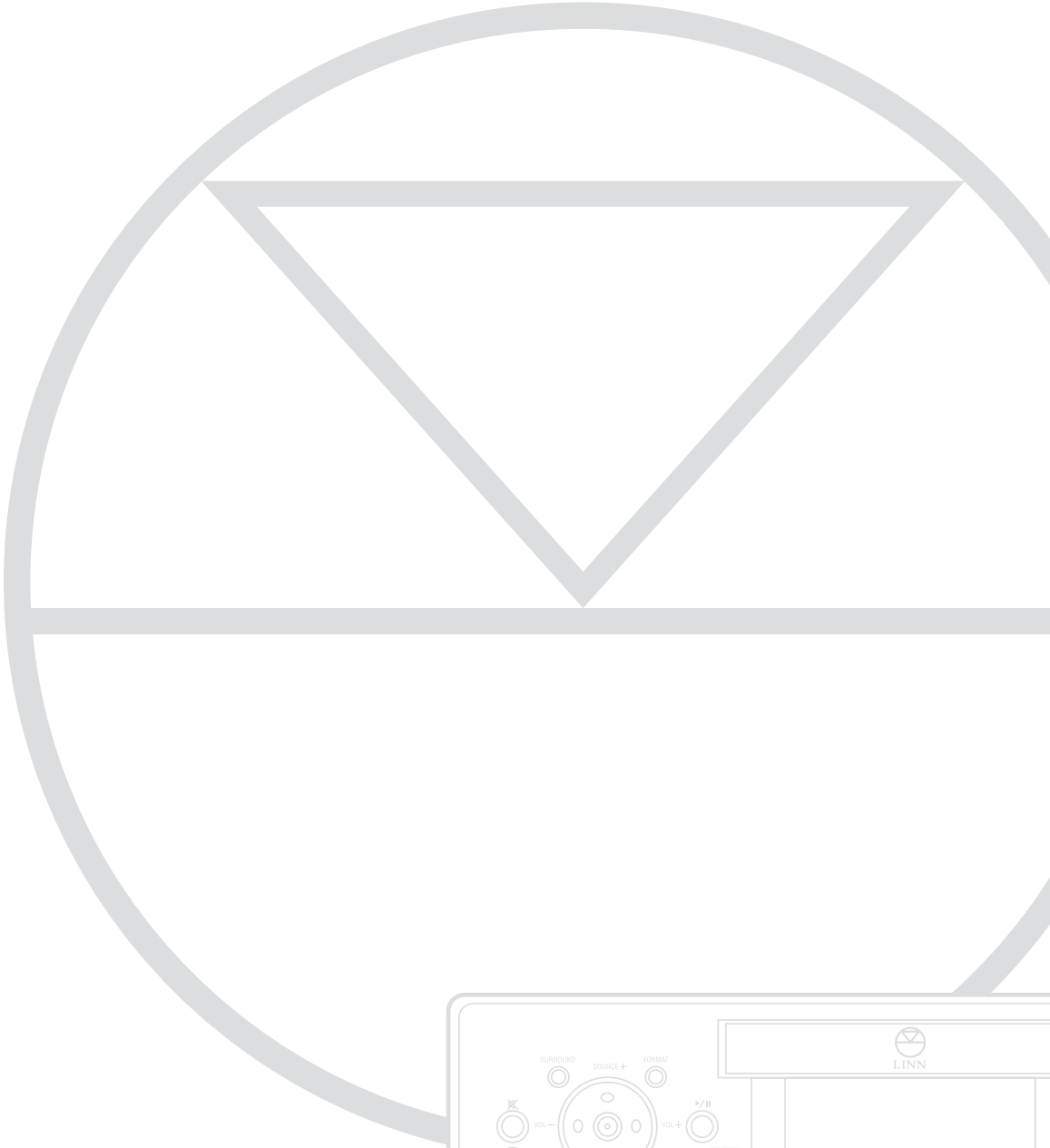

LINN

English

CLASSIK MOVIE  
OWNER'S MANUAL





## Important Safety Information

Explanation of symbols used in this manual and on the product:



This symbol is intended to alert the user to the presence of uninsulated dangerous voltages within the enclosure of sufficient magnitude to cause electric shock.



This symbol is intended to alert the user to the presence of important operation, maintenance and servicing information in the instruction and service manuals.

### CAUTION

TO REDUCE THE RISK OF ELECTRIC SHOCK DO NOT REMOVE THE COVER.

NO USER SERVICEABLE PARTS INSIDE.

REFER SERVICING TO QUALIFIED SERVICE PERSONNEL.

REPLACE THE MAINS FUSE IN THE PLUG WITH ONE OF THE SAME TYPE AND RATING.

DISCONNECT SUPPLY CORD BEFORE CHANGING FUSE.

### WARNING

TO REDUCE THE RISK OF FIRE OR ELECTRIC SHOCK DO NOT EXPOSE THIS APPLIANCE TO RAIN OR MOISTURE.  
SHOCK HAZARD. DO NOT OPEN.

### MAINS PLUGS

This appliance is supplied with a non-rewireable mains plug for the intended country.

Replacement mains leads can be obtained from your Linn retailer. Should you need to change the plug please dispose of it carefully. A plug with bared conductors is dangerous if engaged in a live socket.

The Brown wire must be connected to the Live (Line) supply pin.

The Blue wire must be connected to the Neutral supply pin.

The Green/Yellow wire must be connected to the Earth (Ground) supply pin.

Please contact your retailer or a competent electrician if you are in any doubt.

## GENERAL SAFETY INSTRUCTIONS

1. **Read instructions.** Read the safety and operating instructions before operating the appliance.
2. **Retain instructions.** Retain the safety and operating instructions for future reference.
3. **Heed warnings.** Observe all warnings on the appliance and in the operating instructions.
4. **Follow instructions.** Follow all operating and use instructions.
5. **Water and moisture.** Do not use the appliance near water, for example near a bathtub, washbowl, kitchen sink, laundry tub, in a wet basement, or near a swimming pool and the like.
6. **Carts and stands.** Use only with a cart or stand that is recommended by the manufacturer.
- 6a. An appliance and cart combination should be used with care. Quick stops, excessive force, and uneven surfaces may cause the appliance and cart combination to overturn.
7. **Wall or ceiling mounting.** Mount to a wall or ceiling only as recommended by the manufacturer.
8. **Ventilation.** Site the appliance so that its location or position does not interfere with its proper ventilation. For example, the appliance should not be situated on a bed, sofa, rug, or similar surface that may block the ventilation openings, or placed in a built-in installation such as a bookcase or cabinet that may impede the flow of air through the ventilation openings.
9. **Heat.** Site the appliance away from heat sources such as radiators, heaters, stoves, or other appliances (including amplifiers) that produce heat.
10. **Power sources.** Connect the appliance to a power supply only of the type described in the operating instructions or marked on the appliance.
11. **Grounding or polarisation.** Do not defeat the safety purpose of the polarised or grounding type plug. A polarised plug has two blades with one wider than the other. A grounding type plug has two blades and a third grounding prong. The wide blade or the third prong is provided for your safety. When the provided plug does not fit into your outlet, consult an electrician for replacement of the obsolete outlet.
12. **Power cord protection.** Route power cords so that they are not likely to be walked on or pinched by items placed upon or against them, paying particular attention to cords at plugs, power sockets, and at the point where they exit from the appliance.
13. **Protective attachment plug.** As a safety feature the product is equipped with an attachment plug containing overload protection. See the instruction manual about resetting or replacing the plug. Should the plug need replacing ensure that a replacement is used which has the same overload protection as the original.
14. **Cleaning.** The product should be cleaned only as recommended by the manufacturer.
15. **Power lines.** An outdoor antenna should be located away from power lines.
16. **Outdoor antenna grounding.** If an outdoor antenna is connected to the tuner/receiver, ensure that the antenna system is grounded to provide some protection against voltage surges and static build up. In the USA see article 810 of the National Electrical Code ANSI/NFPA 70 concerning installation requirements.



- 17. Lightning storms.** Unplug this apparatus during lightning storms or when unused for long periods of time.
- 18. Objects and liquid entry.** Do not let objects or liquids fall into the product. Do not expose the product to dripping or splashing. Do not place a vessel containing liquid on top of the product.
- 19. Damage requiring service.** The product should be serviced by qualified personnel if:
- The power cord or plug has been damaged.
  - Objects or liquid have fallen into the product.
  - The product has been exposed to rain.
  - The product does not appear to operate normally or exhibits a marked change in operation.
  - The product has been dropped or the enclosure damaged.
- 20. Servicing.** Do not attempt to service the product beyond that described in the operating instructions. All other servicing should be referred to qualified service personnel.

## UK USERS PLEASE READ THIS IMPORTANT SAFETY INFORMATION

### Fuse replacement

This appliance is fitted with a non-rewireable 13 Amp mains plug. The plug contains a 5 Amp fuse. If the fuse has blown it can be replaced as follows:

- Pull out the red fuse cover/carrier.
- Remove and dispose of the blown fuse.
- Fit a new 5 Amp BS1362 approved fuse into the carrier and push the carrier back into the plug.

Always ensure the fuse cover is fitted. If the fuse cover is missing do not use the plug. Contact your Linn retailer to obtain a replacement fuse cover.

Fuses are for fire protection and do not protect against electric shock.

### Mains plug replacement

Should your mains plug need replacing and you are competent to do this proceed as follows. If you are in doubt contact your Linn retailer or a competent electrician.

- Disconnect the plug from the mains supply.
- Cut off the plug and dispose of it safely. A plug with bared conductors is dangerous if engaged in a live socket.
- Only fit a 13 Amp BS1363A approved plug with a 5 Amp fuse.
- The cable wire colours or a letter will be marked at the connection points of most quality plugs.

Attach the wires securely to their respective points. The Brown wire must go to the Live pin, the Blue wire must go to the Neutral pin, and the Green/Yellow wire must go to the Earth pin.

- Before replacing the plug top ensure that the cable restraint is holding the outer sheath of the cable firmly and that the wires are correctly connected.

### WARNING

THIS APPLIANCE MUST BE EARTHED.

## CE Declaration of Conformity

Linn Products Ltd declare that this product is in conformance with the Low Voltage Directive 73/23/EEC and Electromagnetic Compatibility 89/336/EEC as amended by 92/31/EEC and 93/68/EEC.

The conformity of the designated product with the provisions of Directive number 73/23/EEC (LVD) is proved by full compliance with the following standards:

Standard number	Date of issue	Test type
EN60065	1998	General requirements Marking Hazardous radiation Heating under normal conditions Shock hazards under normal operating conditions Insulation requirements Fault conditions Mechanical strength Parts connected to the mains supply Components Terminal devices External flexible cords Electrical connections and mechanical fixings Protection against electric shock Stability and mechanical hazards Resistance to fire

The conformity of the designated product with the provisions of Directive number 89/336/EEC (EMC) is proved by full compliance with the following standards:

Standard number	Date of issue	Test type
EN55013	2001	Conducted emissions
EN55013	2001	Absorbed emissions
EN55020	2002	Immunity

## FCC notice

NOTE:

This equipment has been tested and found to comply with the limits for a Class B digital device, pursuant to Part 15 of the FCC Rules. These limits are designed to provide reasonable protection against harmful interference in a residential installation. This equipment generates, uses and can radiate radio frequency energy and, if not installed and used in accordance with the instructions, may cause harmful interference to radio communications. However, there is no guarantee that interference will not occur in a particular installation.

If this equipment does cause harmful interference to radio or television reception, which can be determined by turning the equipment off and on, the user is encouraged to try to correct the interference by one or more of the following measures:

- Reorient or relocate the receiving antenna.
- Increase the separation between the equipment and receiver.
- Connect the equipment into an outlet on a circuit different from that to which the receiver is connected.
- Consult the dealer or an experienced radio/TV technician for help.



## Copyright and Acknowledgements

Copyright © 2003 Linn Products Ltd. First edition 2002.

Linn Products Limited, Floors Road, Waterfoot, Glasgow, G76 OEP, Scotland, United Kingdom

All rights reserved. No part of this publication may be reproduced, stored in a retrieval system, or transmitted, in any form or by any means, electronic, mechanical, photocopying, recording, or otherwise, without the prior written permission of the publisher.

Printed in the United Kingdom.

**Linn** and the Linn logo are registered trade marks of Linn Products Limited.  
**CLASSIK** is a trade mark of Linn Products Limited.

DVD Logo is a trademark of DVD Format/Logo Licensing Corporation.

“DTS” and “DTS Digital Surround” are registered trade marks of Digital Theater Systems, Inc.

Manufactured under license from Dolby Laboratories. “Dolby”, “Pro Logic” and the double-D symbol are trade marks of Dolby Laboratories.

This product incorporates copyright protection technology that is protected by method claims of certain U.S. patents and other intellectual property rights owned by Macrovision Corporation and other rights owners. Use of this copyright protection technology must be authorized by Macrovision Corporation, and is intended for home and other limited viewing uses only unless authorized by Macrovision Corporation. Reverse engineering or disassembly is prohibited.

The information in this manual is furnished for information use only, is subject to change without notice, and should not be construed as a commitment by Linn Products Limited. Linn Products Limited assumes no responsibility or liability for any errors or inaccuracies that may appear in this manual.

Linn Products Limited disclaims any proprietary interest in trade marks and trade names other than its own.

Supply of this product does not convey a license nor imply any right to distribute content created with this product in revenue-generating broadcast systems (terrestrial, satellite, cable and/or other distribution channels), streaming applications (via Internet, intranets and/or other networks), other content distribution systems (pay-audio or audio-on-demand applications and the like) or on physical media (compact discs, digital versatile discs, semiconductor chips, hard drives, memory cards and the like). An independent license for such use is required. For details, please visit <http://mp3licensing.com>

MPEG Layer-3 audio coding technology licensed from Fraunhofer IIS and Thomson.

# Contents

<b>Introduction</b>	<b>3</b>
Discs	3
Surround Sound	3
Cleaning	3
<b>Connecting</b>	<b>4</b>
Unpacking	4
Voltage selection	4
Positioning	4
Back panel (European version)	5
Back panel (US version)	6
Connecting the CLASSIK Movie	7
<b>Front Panel and Handset</b>	<b>11</b>
Front panel	11
Handset	12
Handset modes	12
<b>Video Output</b>	<b>13</b>
<b>Setup Menus</b>	<b>13</b>
About the setup menus	13
General setup	15
Speaker setup	16
Audio setup	18
Preferences	19

<b>Playing Discs</b>	<b>21</b>
First of all	21
Front panel display	21
Basic operation	22
Locating titles/chapters/tracks on a disc	23
Direct title selection	23
Next and previous chapter/track selection	24
Direct chapter selection	24
Direct track selection	24
Replay track	24
Locating a particular point on a disc	25
Fast search forwards and backwards	25
Fast scan forwards and backwards	25
Slow search forwards and backwards	26
Slow scan forwards and backwards	26
Direct time selection	27
Using program modes to control playback	27
Repeat disc	27
Repeat chapter/track	27
Repeat section	28
Shuffle program	28
Intro program	28
Include program	28
Exclude program	29
Using DVD menus	29
Title/DVD menu	29
Further playback options for DVDs	30
Language selection	30
Subtitles	30
Angle selection	30
Zoom and pan	30
Surround sound and audio modes	30
Midnight Movie mode	31
Additional file formats	31



## Contents (continued)

<b>Tuner</b> .....	<b>32</b>
Setup .....	32
First of all .....	32
Tuning functions .....	32
AM and FM band selection .....	32
Frequency selection .....	32
Signal searching .....	33
Signal scanning .....	33
Signal mute level .....	34
Preset functions .....	35
Preset storage .....	35
Automatic preset storage .....	35
Preset selection .....	36
Preset deletion .....	36
<b>Preamplifier</b> .....	<b>37</b>
Volume and muting .....	37
Volume adjustment .....	37
Mute and unmute .....	37
Trim adjustment .....	38
Subwoofer trim .....	38
Centre speaker trim .....	38
Balance adjustment .....	39
Fader balance .....	39
Master balance .....	39
Bass and treble adjustment .....	40
Bass adjustment .....	40
Treble adjustment .....	40
<b>Record Function</b> .....	<b>41</b>
Making a recording .....	41
Record lock .....	41

## **CONNECT Feature** .....

About CONNECT .....	42
Setting up a CONNECT system .....	42
Main Mode and Local Mode .....	43
Switching between Main Mode and Local Mode .....	43
Controlling the driver unit from a receiver unit .....	43
Party Mode .....	43
Restrictions to Party Mode .....	44
Volume control in Party Mode .....	44
Party Poop .....	44

## **User Options** .....

Changing the user options' settings .....	45
Table of user options .....	45

## **Guarantee and Service** .....



## Introduction

### Discs

The following types of disc can be played on the CLASSIK™ Movie:

Type	Contents	Size
DVD video	audio + video (MPEG2)	8cm / 12cm
CD CD-R CD-RW	audio (MP3) audio + video (JPEG, MPEG2)	8cm / 12cm

### Important Note: Disc formats

Whilst every effort has been made to ensure universal compatibility with all approved disc types, it is impossible to guarantee full operation of every function of the CLASSIK Movie with every disc that is on sale now or in the future. We have tested many of the disc types that are currently available but many discs that are on sale at this time do not conform to the published and accepted formal specifications. For this reason, **we are unable to accept any responsibility for the player being unable to playback any particular disc.** If you have discs that do not play on the CLASSIK Movie, which are subsequently found to play on other brands of player, this does not imply that the CLASSIK Movie is in any way at fault. There are many websites that display details of discs that have known playback problems and we suggest that you consult with this published data before you make any judgements regarding the CLASSIK Movie's playback abilities. We welcome the receipt of all suspect discs as this may assist us in ensuring that the CLASSIK Movie continues to develop but cannot accept discs from end users on the basis that we have made any warranty about being able to learn how to play them.

### Novelty discs

Do not play irregularly shaped discs (heart-shaped, business card size etc) in the CLASSIK Movie as they may damage the unit.

### NOTE:

In this manual 'TV' refers to projection TVs and monitors as well as televisions.

### Surround sound

The CLASSIK Movie is equipped with circuitry for processing the audio signal on discs marked with the following logos:



For details on the surround sound modes, see *Surround sound and audio modes in Playing Discs* chapter.

### Cleaning

Disconnect the CLASSIK Movie from the power supply before cleaning. Remove dust and fingerprints with a soft, dry cloth. Avoid using domestic cleaning products on the unit.



## Connecting

This chapter explains how to install your CLASSIK Movie and how to connect it to speakers, TV etc.

### Unpacking

The CLASSIK Movie is supplied with the following accessories:

- handset with booklet
- 2 x R03 (AAA) size batteries for the handset
- AM aerial
- FM aerial
- mains lead
- this manual

We recommend that you retain all packaging in case you need to transport the CLASSIK Movie at a later date.

### Voltage selection



Do not connect the mains supply until you have verified that the CLASSIK Movie is set to the correct voltage for your mains supply.

The CLASSIK Movie is factory-set for a 230 volt mains supply and must not be connected to a mains supply other than this before it is adjusted for your local voltage. To set the voltage, use a screwdriver to adjust the voltage selector on the rear of the unit to the correct setting.



This appliance must be earthed. Use the earthed moulded mains lead supplied. Never use an unearthed plug or adapter.

Mains supply range	Setting on voltage selector
90V – 126V	115V
207V – 253V	230V

### Positioning

You can position your CLASSIK Movie almost anywhere you find convenient, but please consider the following points:

- Allow at least 10cm of space to the sides, rear and above the CLASSIK Movie for air circulation.
- Never block the ventilation holes on the top and sides of the unit.
- The handset is sensitive. You should have no problems operating the CLASSIK Movie with the handset wherever it is placed in a room, provided you keep the CLASSIK Movie out of direct sunlight and you do not obscure the control window.

#### IMPORTANT:

Do not open the CLASSIK Movie's disc drawer if the unit is behind glass doors as this can damage the drawer's mechanism.

## Back panel European version

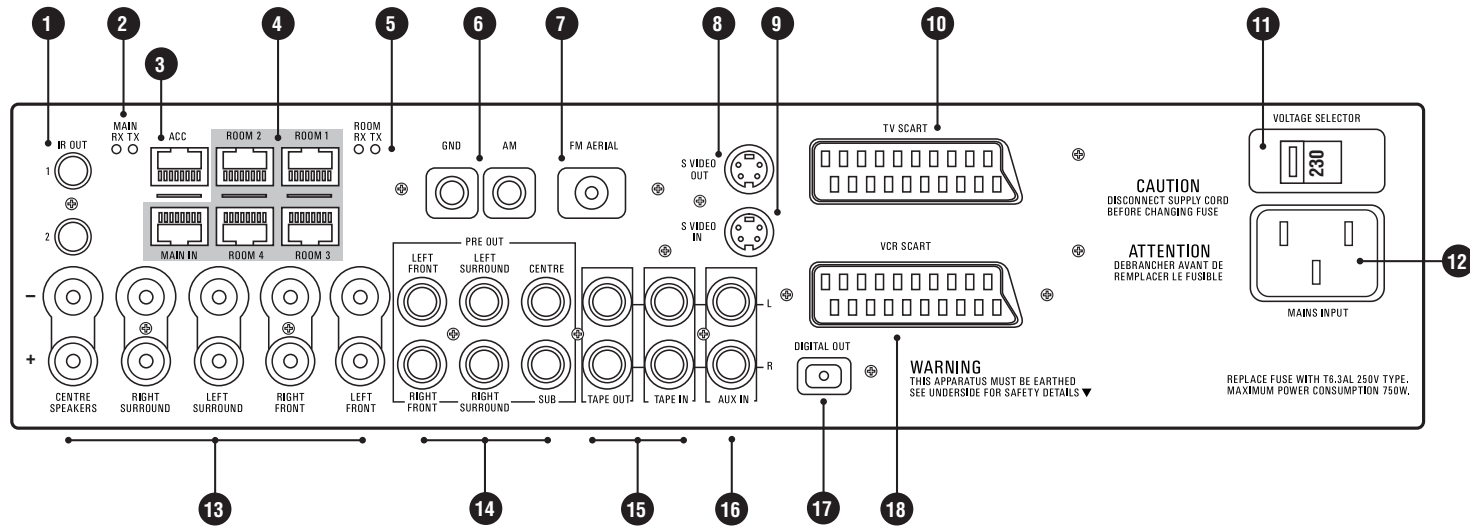

- 1 IR OUT 1, 2** Infrared flasher connectors  
Allow the control via the handset of auxiliary devices that accept infrared signals.
- 2 MAIN RX TX** CONNECT LED indicators  
Indicate signals being transmitted between units in a CONNECT system.
- 3 ACC** KNEKT connector  
For installing unit in a KNEKT system.
- 4 ROOM 1 - 4, MAIN IN** CONNECT connectors  
For linking units in a CONNECT system (see *CONNECT* chapter).
- 5 ROOM RX TX** CONNECT LED indicators  
Indicate signals being transmitted between units in a CONNECT system.
- 6 GND, AM**  
AM aerial connectors.
- 7 FM AERIAL**  
FM aerial connector.
- 8 S VIDEO OUT** S-video output  
For connection to a TV that accepts an S-video signal.
- 9 S VIDEO IN**  
For connection from a VCR with an S-video output.
- 10 TV SCART**  
For connection to the SCART socket on a TV.
- 11 VOLTAGE SELECTOR**
- 12 MAINS INPUT**
- 13 Speaker output connectors**  
Amplified output for direct connection to speakers.
- 14 PRE OUT** Line output connectors  
Connections for power amplifier, and subwoofer output.
- 15 TAPE OUT, TAPE IN**  
For connection to a tape recorder.
- 16 AUX IN**  
Input from an auxiliary source.
- 17 DIGITAL OUT**  
For connection to a device with digital input capabilities.
- 18 VCR SCART**  
For connection from the SCART socket on a VCR.



The CLASSIK Movie should be powered down then disconnected from the mains supply before connecting or disconnecting any of the plugs on the back panel. If this is not done you may generate surges which could damage the CLASSIK Movie or other components in your AV system.



## Back panel US version

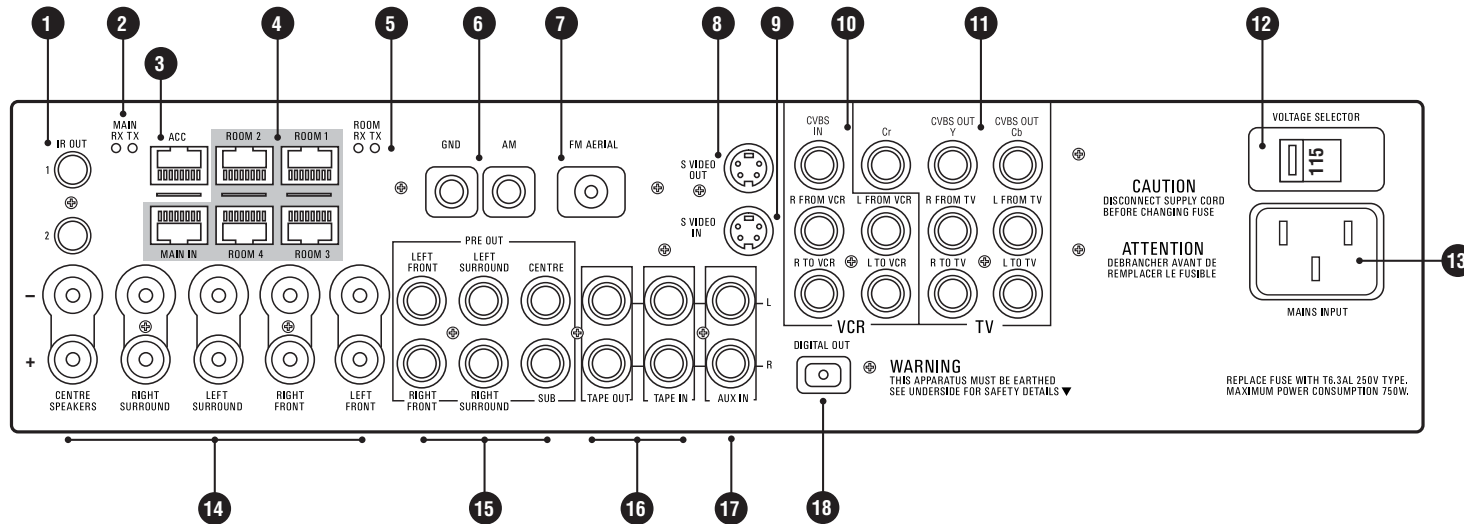

- 1 IR OUT 1, 2** Infrared flasher connectors  
Allow the control via the handset of auxiliary devices that accept infrared signals.
- 2 MAIN RX TX** CONNECT LED indicators  
Indicate signals being transmitted between units in a CONNECT system.
- 3 ACC** KNEKT connector  
For installing unit in a KNEKT system.
- 4 ROOM 1 - 4, MAIN IN** CONNECT connectors  
For linking units in a CONNECT system (see *CONNECT* chapter).
- 5 ROOM RX TX** CONNECT LED indicators  
Indicate signals being transmitted between units in a CONNECT system.
- 6 GND, AM**  
AM aerial connectors.
- 7 FM AERIAL**  
FM aerial connector.
- 8 S VIDEO OUT**  
For connection to a TV that accepts an S-video signal.
- 9 S VIDEO IN**  
For connection from a VCR with an S-video output.
- 10 VCR input and output connectors**

- 11 TV input and output connectors**
- 12 VOLTAGE SELECTOR**
- 13 MAINS INPUT**
- 14 Speaker output connectors**  
Amplified output for direct connection to speakers.
- 15 PRE OUT** Line output connectors  
Connections for power amplifier, and subwoofer output.
- 16 TAPE OUT, TAPE IN**  
For connection to a tape recorder.
- 17 AUX IN**  
Input from an auxiliary source.
- 18 DIGITAL OUT**  
For connection to a device with digital input capabilities.



The CLASSIK Movie should be powered down then disconnected from the mains supply before connecting or disconnecting any of the plugs on the back panel. If this is not done you may generate surges which could damage the CLASSIK Movie or other components in your AV system.

## Connecting the CLASSIK Movie

Full details on connecting the CLASSIK Movie are contained in this section.

### NOTE:

In this manual 'TV' refers to projection TVs and monitors as well as televisions.

### Connecting to a mains supply

#### IMPORTANT:

Do not turn on the mains supply until you have connected all other components.

Connect the CLASSIK Movie to a mains supply using the mains lead provided.

When any connections are made to speakers or a TV, the CLASSIK Movie must be configured before they will operate correctly. This is fully explained in the *Setup Menus* chapter.

Once all relevant connections have been made, turn on the mains supply. The  symbol appears on the front panel display. This symbol means the unit is in standby mode.

### Connecting the CLASSIK Movie to other components

For the best performance, the video outputs from auxiliary sources should be connected directly to your TV, and the audio outputs to your CLASSIK Movie – see diagram below.

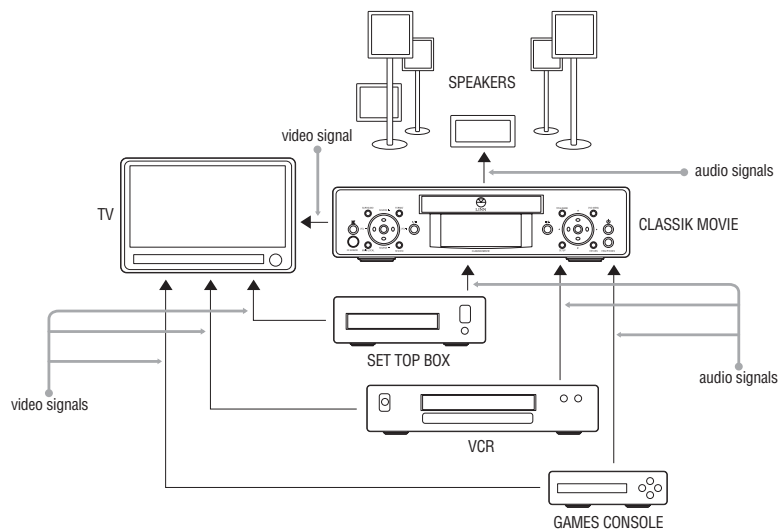

If you prefer, or if your TV does not have sufficient connections, you can connect the audio and video outputs to the CLASSIK Movie. If you have the European version of the CLASSIK Movie you can do this by daisy-chaining your auxiliary components and having one connection to the unit – see diagram below.

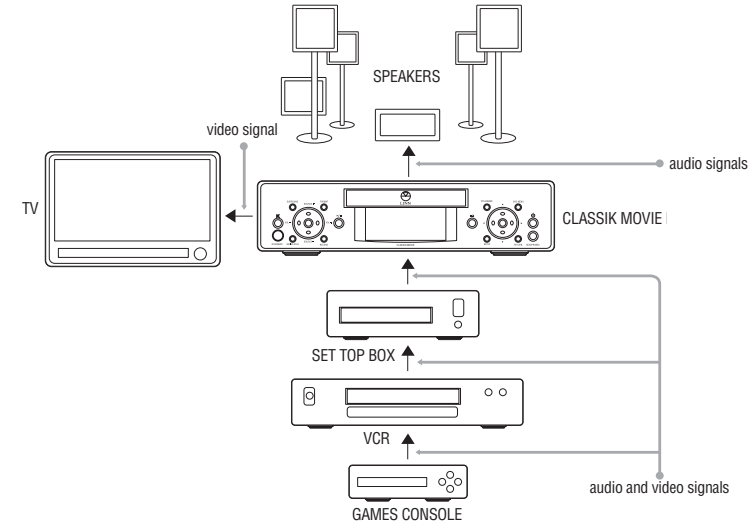

If you have the US version, you can connect the audio and video outputs from your auxiliary sources individually to the CLASSIK Movie – see diagram below.

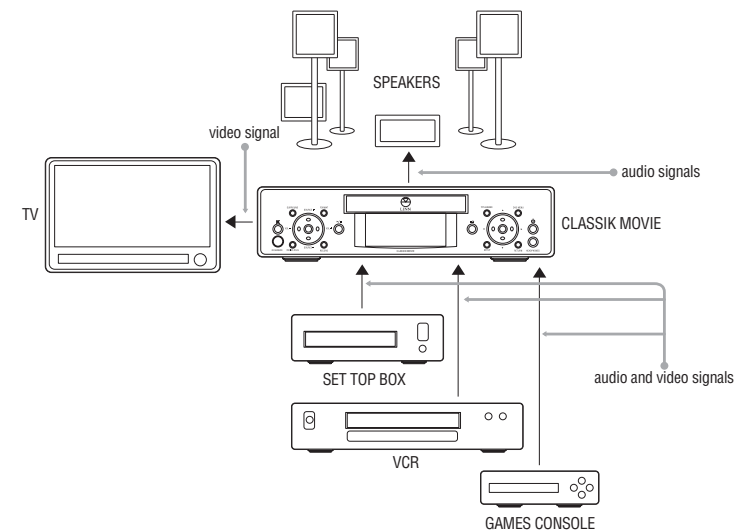



### Connecting the aerials

Connect the supplied AM and FM aerials as shown.

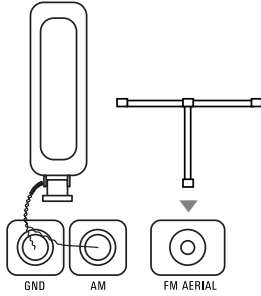

### Connecting to a TV (European version)

If your TV is fitted with an S-video input socket, connect as shown.

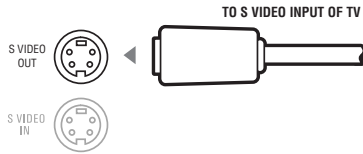

If your TV does not have an S-video input socket, connect the CLASSIK Movie to the TV's SCART socket.

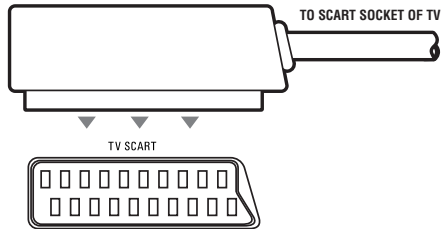

### Connecting to a TV (US version)

If your TV is fitted with YCrCb/YUV input sockets, connect the CLASSIK Movie to your TV as shown.

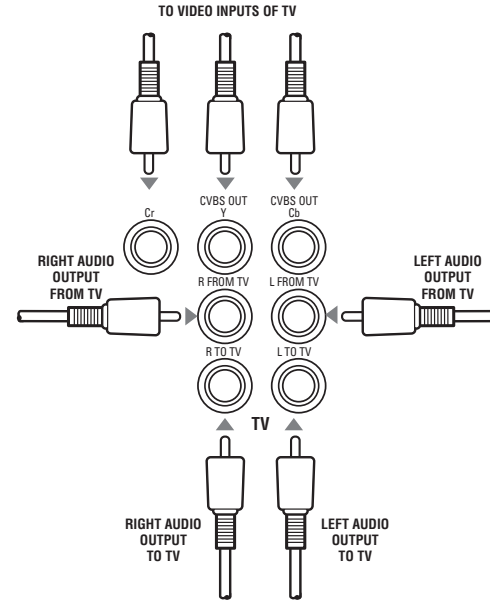

If your TV is fitted with an S-video input socket, connect as shown.

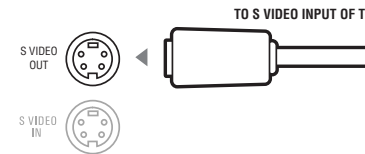

If your TV/display device does not have an S-video or YCrCb/YUV input sockets, connect the Classik Movie to the TV/display device as shown.

**NOTES:**

Ensure your TV/display device is set to accept either a Composite, S-video or YCrCb/YUV input. If your TV/display device is set to accept an RGB signal it will not display a picture from the Classik Movie.

If you do not wish to hear the audio signal from the Classik Movie through your TV/display device, do not connect the R TO TV and L TO TV outputs.

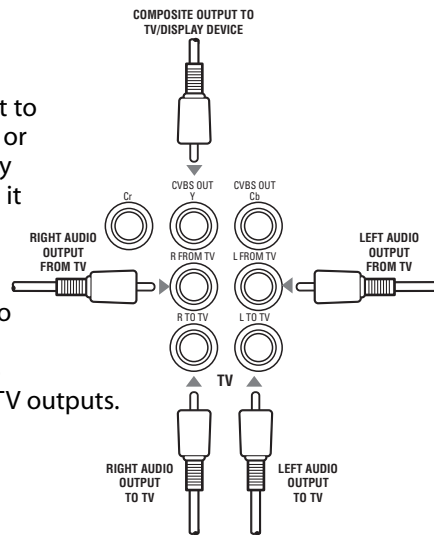

**Connecting to a VCR (European version)**

Connecting the CLASSIK Movie to your VCR depends on the connections available on the VCR. See your VCR's instruction booklet for guidance.

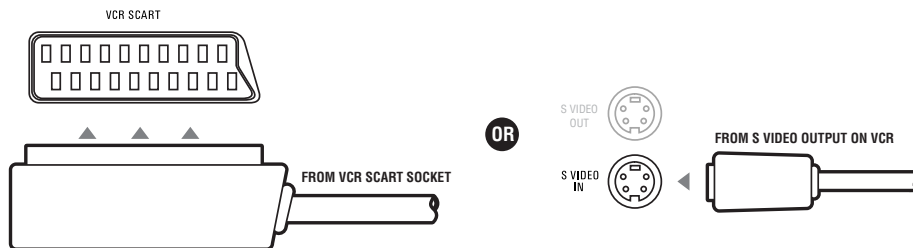

**NOTE:**

Do not have two different sources connected to the S VIDEO IN and VCR SCART sockets at the same time.

**Connecting to a VCR (US version)**

Connecting the CLASSIK Movie to your VCR depends on the connections available on the VCR. See your VCR's instruction booklet for guidance.

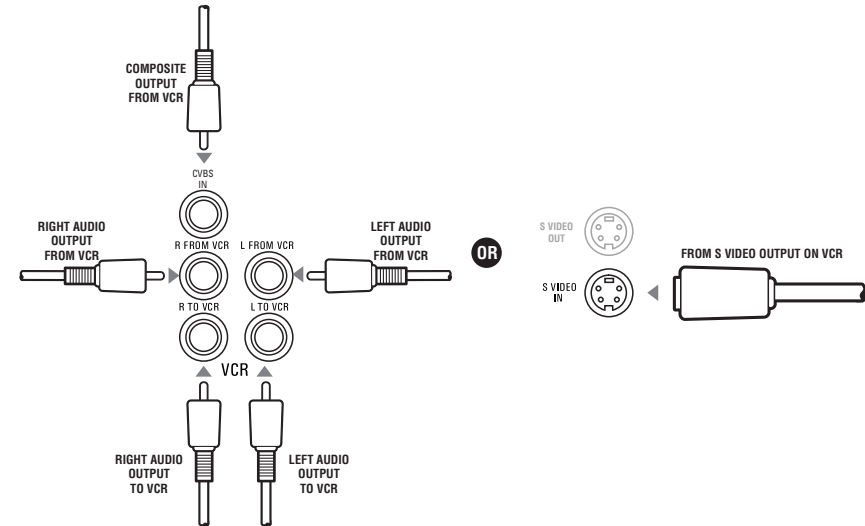

**Connecting to an external power amplifier**

If you are using an external power amplifier to feed audio signals to your speakers, follow the diagram below.

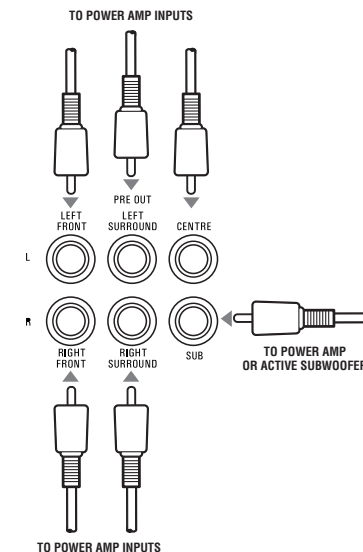



## Connecting to speakers

If you are not using an external power amplifier and are therefore connecting speakers directly to the CLASSIK Movie, follow the diagram below.

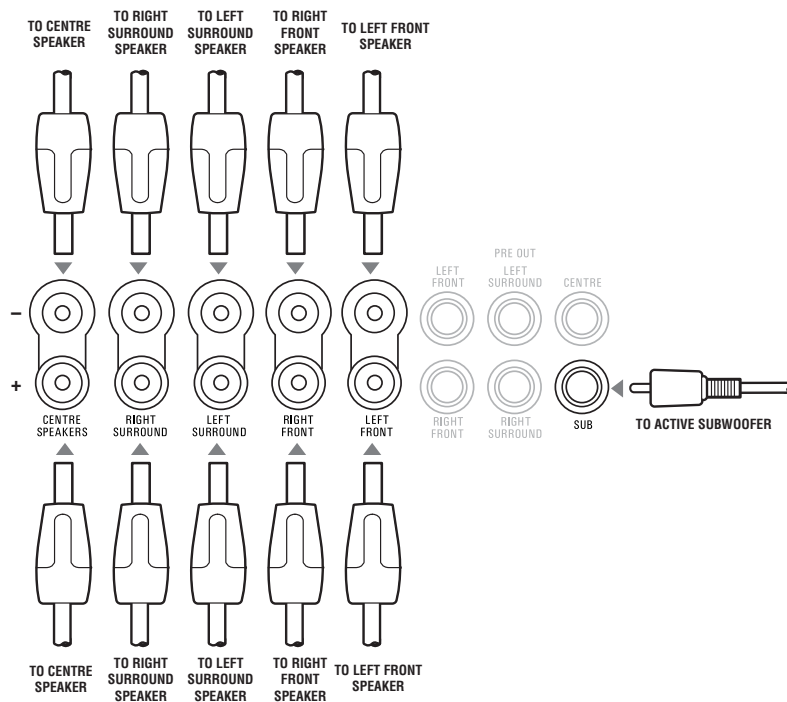

## Connecting to an auxiliary analogue source

Connect the CLASSIK Movie's AUX IN sockets to the output from an external audio source, such as the analogue output of a Mini Disc player or external tuner.

## Connecting to a device with digital input capabilities

Connect the CLASSIK Movie's DIGITAL OUTPUT to a device with a digital input such as a Mini Disc player, digital tape recorder or external home cinema decoder.

## Connecting to an analogue tape recorder

Follow the diagram below.

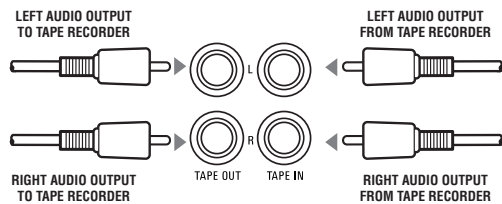



# Front Panel and Handset

## Front panel

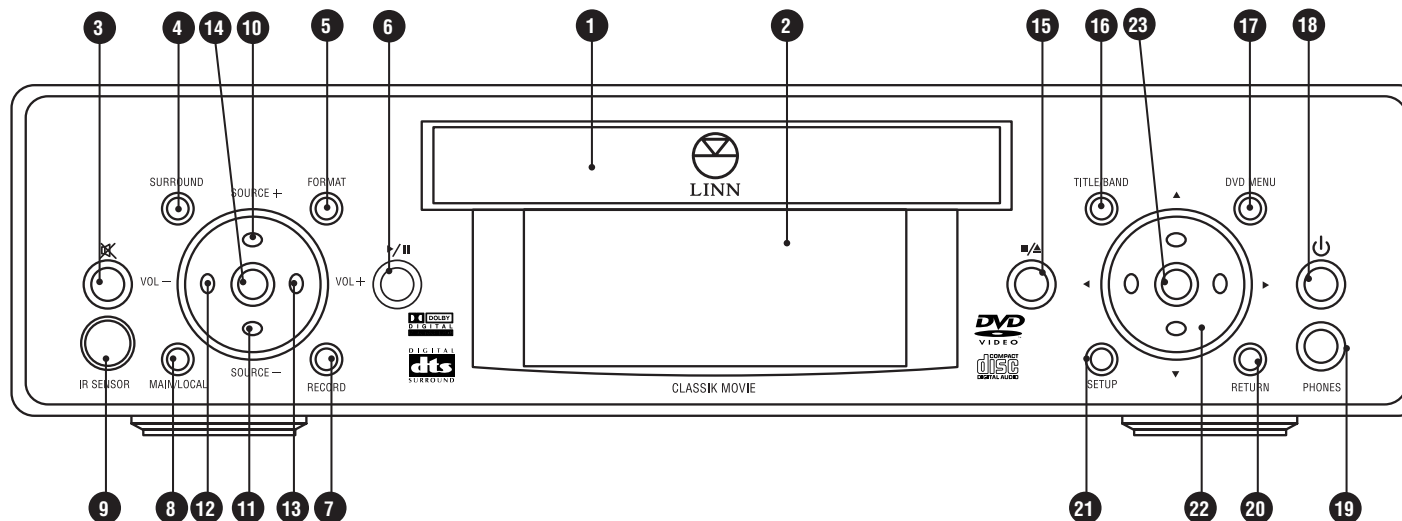

- 1 **Disc drawer**
- 2 **Front panel display**
- 3 **ⓧ (mute)** Mutes/unmutes the sound to the speakers and headphones.
- 4 **SURROUND** Selects a surround sound format.
- 5 **FORMAT** Selects the type of output video signal.
- 6 **▶/|| (play/pause)** Plays or pauses a disc.
- 7 **RECORD** Selects a source for recording.
- 8 **MAIN/LOCAL** Used if the unit is part of a CONNECT system.
- 9 **IR SENSOR** Sensor for receiving signals from the handset.
- 10 & 11 **SOURCE + / -** Select a source.
- 12 & 13 **VOL - / +** Adjust the volume level.
- 14 **'adjust'** Selects a function to be adjusted and also modifies the function of the VOL - / + keys.
- 15 **■/▲ (stop/eject)** Stops a disc playing. Opens/closes the disc drawer.
- 16 **TITLE/BAND** Enters a DVD title menu. Switches tuner band.
- 17 **DVD MENU** Enters a DVD menu.
- 18 **⏻ (power)** Brings unit out of, or puts into, standby mode.
- 19 **PHONES** Headphones connector.
- 20 **RETURN** Restarts current CD track.
- 21 **SETUP** Enters/exits setup menus.
- 22 **▲/▼/◀/▶** For navigating setup menus and adjusting settings.
- 23 **'enter'** Executes a setting.

Some keys have additional functions that are dependent on the current source or mode.



## Handset

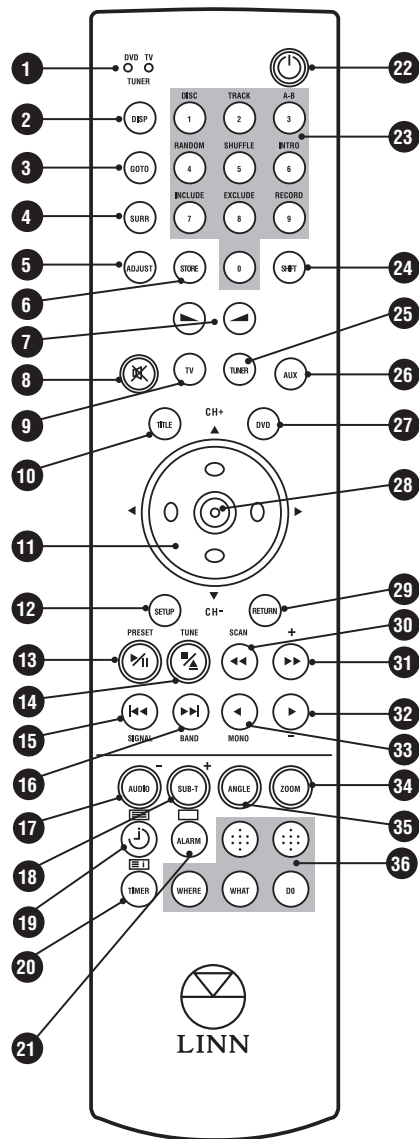

- 1 **LEDs** Indicate when a signal is being transmitted from the handset.
- 2 **DISP (display)** Changes the time display on the front panel when playing discs.
- 3 **GOTO** For jumping to a particular title, chapter, track or time on a disc.
- 4 **SURR (surround)** Selects sound formats.
- 5 **ADJUST** Selects a function to be adjusted.
- 6 **STORE** Stores disc and tuner information.
- 7 **▶ (volume -) / ◀ (volume +)** Adjust the volume level.
- 8 **⊘ (mute)** Mutes/unmutes the sound to the speakers and headphones.
- 9 **TV** Selects TV mode.
- 10 **TITLE** Enters a DVD title menu.
- 11 **CH + / CH - / ▲ / ▼ / ◀ / ▶** Changes TV channel. For navigating setup menus and adjusting settings.
- 12 **SETUP** Enters/exits on-screen setup menus.
- 13 **▶ / || (play/pause) / PRESET** Plays or pauses a disc. For selecting a tuner preset.
- 14 **■ / ▲ (stop/eject) / TUNE** Stops a disc playing. Opens/closes the disc drawer. For selecting a tuner frequency.
- 15 **◀◀ / SIGNAL** Previous chapter/track selection. Displays tuner signal strength.
- 16 **▶▶ / BAND** Next chapter/track selection. Tuner band selection.
- 17 **AUDIO / - \* / red fast-text key\*\*** For selecting audio language on DVDs. For setting clock and alarm.\* Teletext operation.\*\*
- 18 **SUB-T / + \* / green fast-text key\*\*** Switches DVD subtitles on or off. For setting clock and alarm.\* Teletext operation.\*\*
- 19 **⌚ \* / ≡ \*\*** For setting clock.\* Turns teletext on.\*\*
- 20 **TIMER \* / ≡ \*\*** For setting timer.\* Jumps to teletext index page.\*\*
- 21 **ALARM \* / □ \*\*** For setting alarm.\* Turns teletext off.\*\*
- 22 **⏻ (power)** Brings unit out of, or puts into, standby mode.

- 23 **Digits 0-9 / Shifted functions\*\*\*** Numeric keys. Access to certain additional functions.\*\*\*
- 24 **SHIFT** Allows access to additional function on certain keys.
- 25 **TUNER** Selects tuner mode.
- 26 **AUX** For selecting auxiliary input/output sources.
- 27 **DVD** For selecting DVD/CD mode.
- 28 **'enter'** Executes a setting.
- 29 **RETURN** Restarts current CD track.
- 30 **◀◀ / SCAN** Fast search backwards. Scans for tuner signals.
- 31 **▶▶ / +** Fast search forwards. Used in tuner functions.
- 32 **▶ / -** Fast scan forwards. Used in tuner functions.
- 33 **◀ / MONO\*\*\*** Fast scan backwards. Toggles between mono and stereo audio outputs.\*\*\*
- 34 **ZOOM / blue fast-text key\*\*** Magnifies screen image. Teletext operation.\*\*
- 35 **ANGLE / yellow fast-text key\*\***. Selects available viewing positions on DVDs. Teletext operation.\*\*
- 36 **KNEKT functions** Used if the unit is installed in a KNEKT system.

\* The clock, timer and alarm keys are not functional for this product but may function with other Linn products.  
 \*\* Teletext functions are not available on the US version of the handset.  
 \*\*\* The RANDOM and MONO commands are not currently functional.

## Handset modes

Pressing a source key (DVD, TUNER, TV or AUX) on the handset will put the handset into the mode of that source. The function of the handset keys varies for the different sources, so you may find that occasionally when using the handset the CLASSIK Movie does not respond as expected. This is because the handset and the unit are set to different sources. To correct this, simply press the key on the handset for the desired source.

## Video Output

The output video signal that is correct for your TV can be selected using the **FORMAT** key on the front panel.

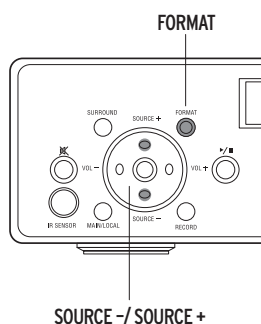

### To do this:

- Repeatedly press or hold **SOURCE + / SOURCE -** on the front panel until the display shows LISTEN DISC / RECORD OFF.
- Repeatedly press **FORMAT** to select the required format (either PAL, NTSC or MULTI if your TV accepts both PAL and NTSC).
- With the required format showing on the front panel display, press and hold **FORMAT** until the display changes to show one of the video signal types (either S VIDEO, COMPOSITE, YUV, or RGB\*).
- Repeatedly press **FORMAT** until the required video signal type is shown on the display.
- Wait a few seconds for the display to change to the LISTEN DISC / RECORD OFF display.

\*RGB is not available on the US version of the CLASSIK Movie.

## Setup Menus

### About the setup menus

The on-screen setup menus enable you to configure your CLASSIK Movie to suit the number and size of your speakers, the picture format of your TV and much more. It is essential that you use the setup menus to inform the unit about components that it is connected to. Please take the time to configure your CLASSIK Movie correctly.

The menus are divided into four categories:

#### GENERAL SETUP

For adjusting the general audio and video setup of the unit.

#### SPEAKER SETUP

For configuring the unit to the number, size and position of your speakers.

#### AUDIO SETUP

For configuring the audio output of the unit.

#### PREFERENCES

For setting up additional features such as subtitles and parental control. (This category cannot be accessed if there is a disc playing in the unit.)

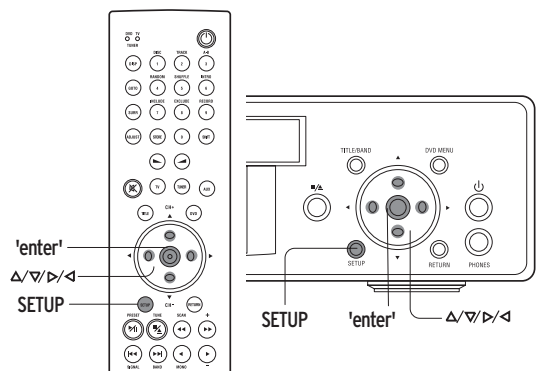

### To access the setup menus:

Ensure your TV is on and tuned to the CLASSIK Movie's output video signal.

- Press **DVD** on the handset.
- Press **SETUP** on the front panel or handset. Your TV screen shows the **SETUP MENU - MAIN PAGE**.

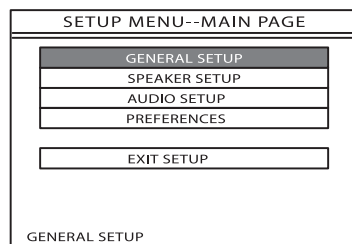

### To navigate the setup menus and make a selection:

- Use the  $\Delta$ ,  $\nabla$ ,  $\blacktriangleleft$ ,  $\blacktriangleright$  keys on the front panel or handset to move around the menus.
- Press **'enter'** on the front panel or handset to select an option.

### EXAMPLE:

If you wanted to change the language used for displaying a DVD menu, you would follow these steps:

1. From the **SETUP MENU - MAIN PAGE** use the  $\nabla$  key on the front panel or handset to move to the **PREFERENCES** option.

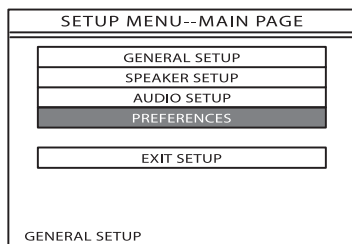

2. Press **'enter'** on the front panel or handset. The **PREFERENCES PAGE** menu is displayed.

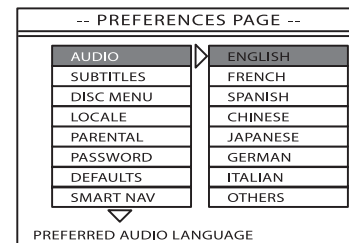

3. Use the  $\nabla$  key to move to the **DISC MENU** option. The language options are displayed.

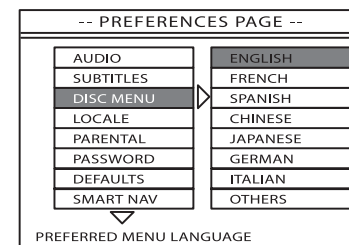

4. Use the  $\blacktriangleright$  key to move to the first language option.
5. Use the  $\nabla$  key to move to the desired language. Press **'enter'**.

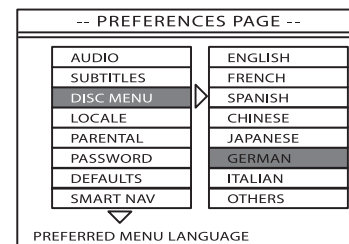

### To exit from the setup menus:

- Press **SETUP** on the front panel.

or

1. Use the  $\nabla$  /  $\Delta$  keys on the front panel or handset to highlight the **MAIN PAGE** option at the bottom of each sub-menu list.

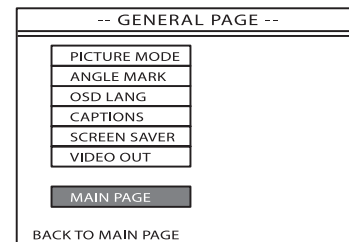



- Press **'enter'** to return to the SETUP MENU - MAIN PAGE.
- Use the **▼** key to highlight the EXIT SETUP option. Press **'enter'**.

Some changes made in the setup menus will be implemented immediately, others will be implemented after exiting setup.

## General Setup

### TV DISPLAY

Choose the option that matches your TV's display; either 4:3, LETTERBOX or 16:9.

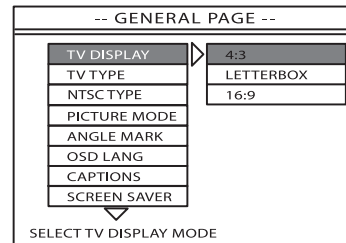
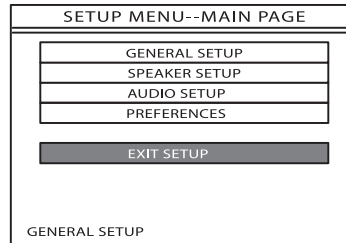

### TV TYPE

(If you have already selected the video signal type for your TV using the FORMAT button (see *Video Output* section), skip this item.)

Choose the option that matches the video signal format accepted by your TV. Set to MULTI if your TV accepts both NTSC and PAL formats.

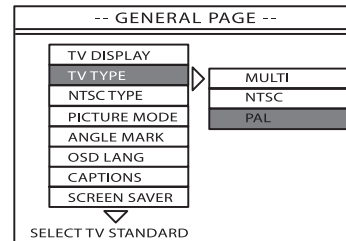

#### NOTES:

If TV TYPE is set to MULTI you may notice the screen flicker when a DVD begins to play. This happens when the CLASSIK Movie switches from one video signal format to the other.

If your TV only accepts one type of format, you may not be able to view DVDs played on the CLASSIK Movie that have been recorded in the other format.

### NTSC TYPE

For countries that use the NTSC TV signal format.  
If in the U.S.A. - set to U.S.  
If not in the U.S.A. - set to WORLD

#### NOTE:

The correct setting may be dependent on the make of your TV. Consult your TV's instruction manual for further information.

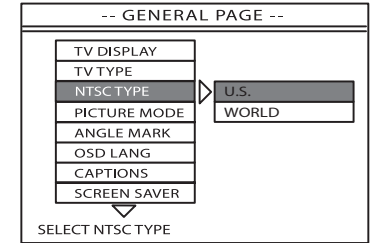

### PICTURE MODE

If when viewing a DVD, moving screen images appear jagged, choose a different option; either AUTO (suitable for most DVDs), HI-RES (high resolution) or N-FLICKER (non-flicker).

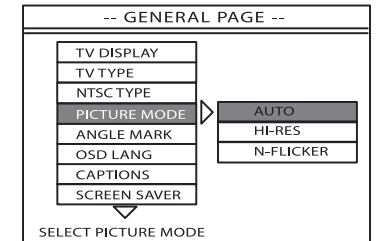

### ANGLE MARK

If set to ON, the  symbol appears on the screen to inform you when a multi-angle portion of a DVD is being played. Next to the symbol the number of available camera angles is also displayed.

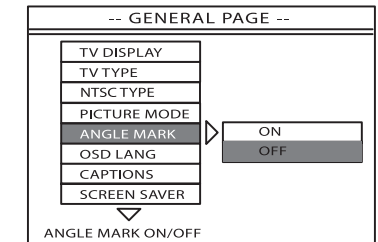

### OSD LANG (on-screen display language)

Choose the language you want on-screen information and menus displayed in.

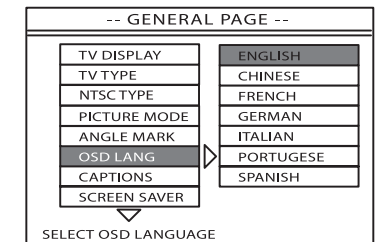



## CAPTIONS

Set to ON to view Closed Captions (for the deaf and hard-of-hearing) that might be available on a DVD.

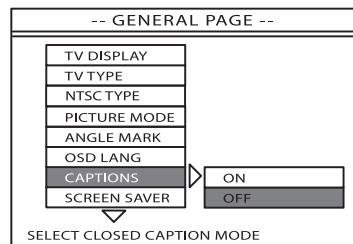

## SCREEN SAVER

If a still image is displayed on your TV screen for too long, damage to your screen can result. Setting to ON activates a screen saver (a blank screen) after three minutes. Press **'enter'** on the front panel or handset to remove the screen saver.

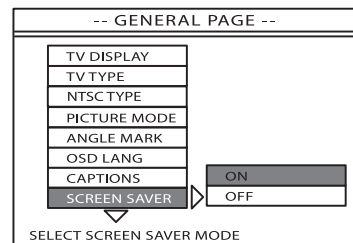

## VIDEO OUT

(If you have already selected the video signal type for your TV using the **FORMAT** button (see *Video Output* section) skip this item.)

(From highest picture quality to lowest.)

If your TV accepts an RGB signal and you have connected your CLASSIK Movie to your TV accordingly, set to RGB.

If your TV accepts a YCrCb or YUV signal and you have connected your CLASSIK Movie to your TV accordingly, set to YUV.

If your TV accepts an S-video signal and you have connected your CLASSIK Movie to your TV accordingly, set to S-VIDEO.

If your TV does not accept an S-video, RGB or YCrCb/YUV signal, set to COMPOSITE.

### NOTE:

The RGB option is not available on the US version of the unit.

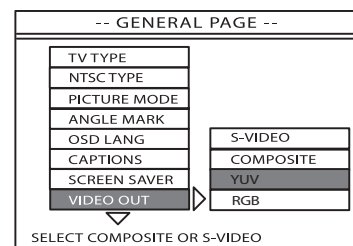

## Speaker Setup

### FRONT

Choose the option that best suits the speakers in your system:

Large front speakers (full-range frequency response) - set to LARGE

Small front speakers (limited bass response) - set to SMALL

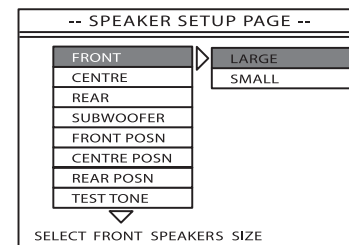

### NOTE:

The setting you choose for your front speakers determines the options available for other speakers.

### CENTRE

Choose the option that best suits the speaker in your system:

Large centre speaker (full-range frequency response) - set to LARGE

Small centre speaker (limited bass response) - set to SMALL

No centre speaker - set to OFF

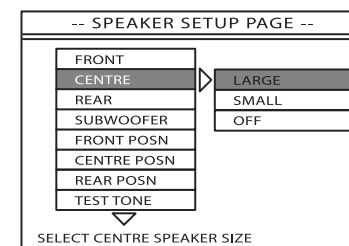

### REAR

Choose the option that best suits the speakers in your system:

Large rear speakers (full-range frequency response) - set to LARGE

Small rear speakers (limited bass response) - set to SMALL

No rear speakers - set to OFF

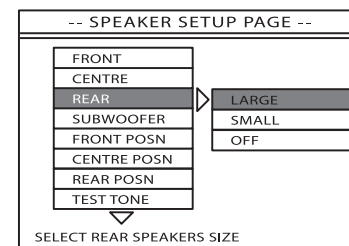

## SUBWOOFER

If you have connected a subwoofer - set to ON

If you have *not* connected a subwoofer - set to OFF

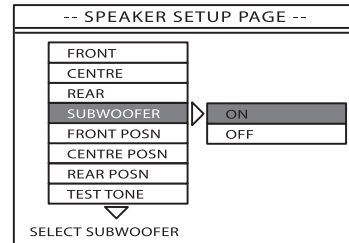

The next menus allow speaker positions to be described to the CLASSIK Movie so that the unit can add time delays to certain speakers. This ensures the sound from all the speakers reaches your seating position at the same time.

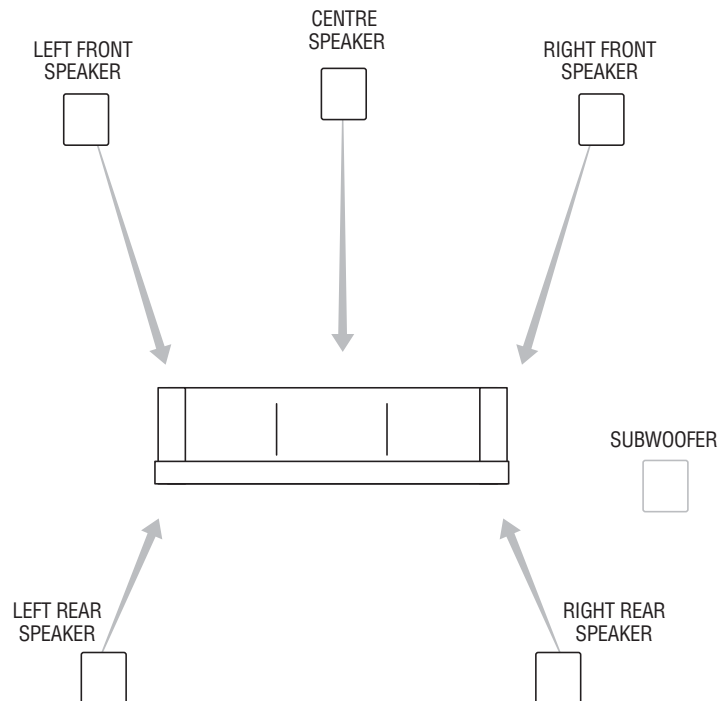

## FRONT POSN (position)

Calculate the approximate distance between your seating position and your front speakers.

Highlight the 5FT/1.5M option, then use the ▼ key on the front panel or handset to increase the distance shown (up to 30FT/9.2M).

Select the appropriate distance by pressing **'enter'** on the front panel or handset.

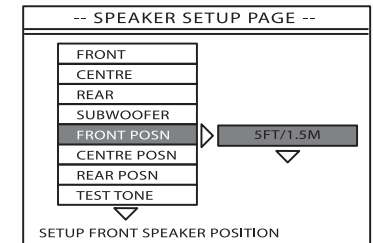

## CENTRE POSN (position)

Calculate the approximate distance between your seating position and your centre speaker.

Highlight the 5FT/1.5M option, then use the ▼ key on the front panel or handset to increase the distance shown (up to 30FT/9.2M).

Select the appropriate distance by pressing **'enter'** on the front panel or handset.

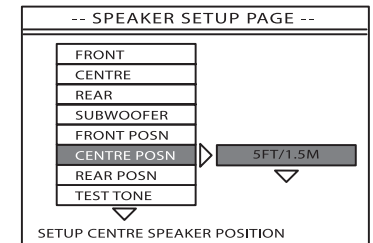

## REAR POSN (position)

Calculate the approximate distance between your viewing position and your rear speakers.

Highlight the 5FT/1.5M option, then use the ▼ key on the front panel or handset to increase the distance shown (up to 30FT/9.2M).

Select the appropriate distance by pressing **'enter'** on the front panel or handset.

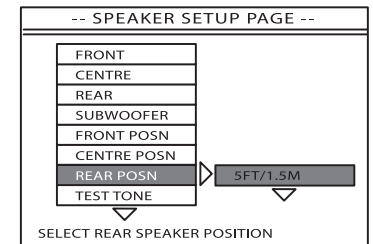

## NOTE:

It is not necessary to add time delay to a subwoofer.



## TEST TONE

When set to ON, a tone signal is sent to all speakers (except a subwoofer) starting with the front left and moving in a clockwise direction. The front panel display shows all possible speakers with the highlighted speaker indicating the current position of the tone.

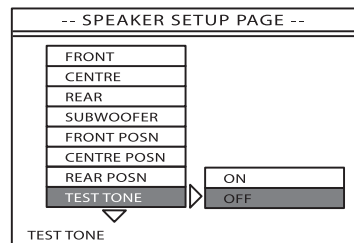

The test tone has two functions:

### 1. Testing speaker connections

If a speaker has not been connected correctly, the tone will either not be heard or will jump to a speaker out of the clockwise sequence (meaning a speaker has been connected to the wrong outputs on the CLASSIK Movie). This feature is not available for the subwoofer.

### 2. Speaker volume trim

This feature can be used to ensure the volume level that reaches your seating position is the same for each speaker (for subwoofer adjustment see *Subwoofer trim* in *Preamplifier* chapter).

#### To perform speaker volume trim:

- Set TEST TONE to ON. The test tone display appears on the CLASSIK Movie's front panel.

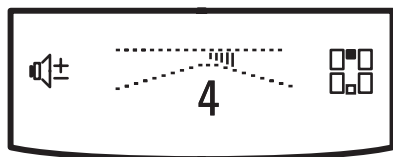

- Wait for the test tone to reach the speaker you wish to adjust.
- Repeatedly press or hold  $\blacktriangleleft$  /  $\blacktriangleright$  on the handset to trim the volume as required.\* Volume trim range is -10 to +10, with neutral trim being 0.

A few seconds after the  $\blacktriangleleft$  /  $\blacktriangleright$  key has been released, the test tone will continue its clockwise direction.

\* You can do this by ear or by using a Sound Pressure Level meter.

## Audio Setup

### AUDIO OUT

If you are using the unit as a stand-alone device, i.e. without using an external decoding device - set to ANALOG.

If you *are* using an external audio decoding device - set to SPDIF/RAW.

When you are recording to an external digital source (e.g. DAT player) - set to SPDIF/PCM.

### OP (operation) MODE

If you are using speakers other than your TV's - set to LINE OUT.

If you are only using your TV's speakers - set to TV OUT.

### DUAL MONO

This menu is for DVDs which have separate audio tracks for the left and right channels.

To hear only the left channel - set to L MONO.

To hear only the right channel - set to R MONO.

To combine the discrete left and right channels - set to MIX MONO.

For normal use (i.e. most DVDs) - set to STEREO.

### DYNAMIC

This feature allows you to add compression to the Dolby Digital audio signal on DVDs. Adding compression reduces sudden increases in volume, such as the sound of an explosion. FULL means minimum dynamic range (maximum signal compression), OFF means maximum dynamic range (no signal compression).

To adjust the dynamic setting use  $\blacktriangle$  /  $\blacktriangledown$  on the front panel or handset.

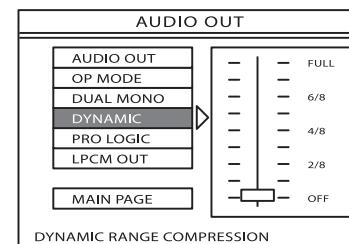
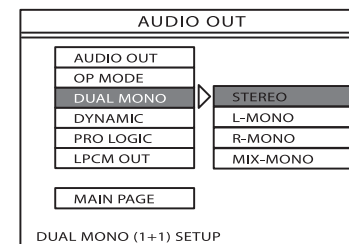
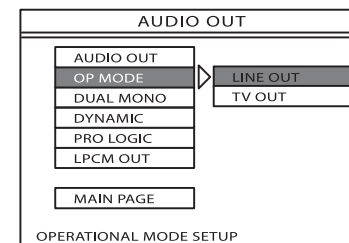
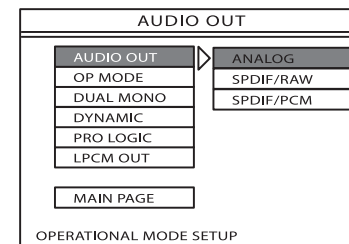



## PRO LOGIC

### For DVD/CD

#### OFF

- Stereo tracks on a DVD/CD will play as stereo.

#### ON

- Stereo tracks on a DVD/CD can be played as stereo or decoded to up to 5 channels (depending on the audio mode selected – see *Surround sound modes* in *Playing Discs* chapter).

#### AUTO

- The unit will read the code embedded on the DVD/CD and automatically choose the audio format.

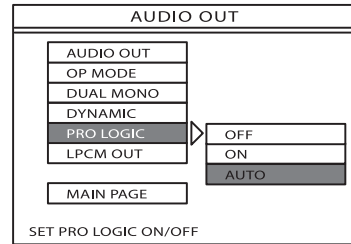

## LPCM OUT

If you are using an external decoder to process the audio signal but the decoder does not support a 96K sample rate, set to the 48K option.

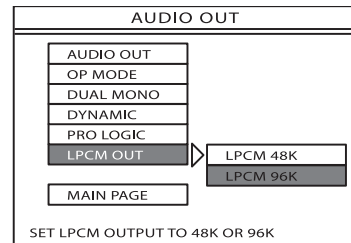

## Preferences

### AUDIO\*

Set to your preferred audio language.

For languages other than the ones shown, highlight OTHERS and press **'enter'**. Using the digit keys on the handset, enter the four-digit code for the desired language. Language codes are available at [www.classik.com](http://www.classik.com)

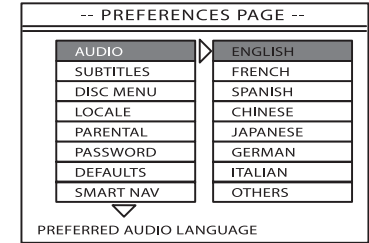

### SUBTITLE\*

Set to your preferred subtitle language. Certain DVDs will play subtitles even if this option is set to OFF. If this happens, subtitles can be removed by pressing **SUB-T** on the handset.

For languages other than the ones shown, highlight OTHERS and press **'enter'**. Using the digit keys on the handset, enter the four-digit code for the desired language. Language codes are available at [www.classik.com](http://www.classik.com).

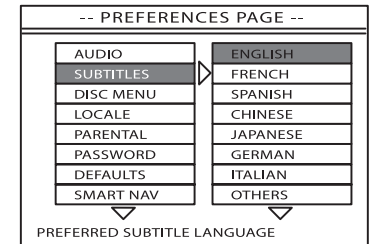

### DISC MENU\*

Set to your preferred DVD menu language. This option is only effective for DVD's which contain multi-language disc menus.

For languages other than the ones shown, highlight OTHERS and press **'enter'**. Using the digit keys on the handset, enter the four-digit code for the desired language. Language codes are available at [www.classik.com](http://www.classik.com)

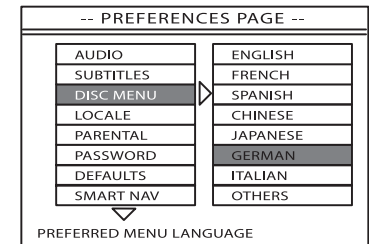

### LOCALE

Not currently functional.

\*Regardless of the language selected, languages available when watching a DVD are dependent on the disc being played.



## PARENTAL

This menu allows you to program the CLASSIK Movie with an age restriction level for certain DVDs.\*

### To set or change parental control:

1. Highlight the desired age restriction level and press **'enter'**. The password verify page appears.
2. Key in a four-digit password using the number keys on the handset (the factory set password is 3308).
3. When prompted on screen press **'enter'**.
4. Exit setup to implement change.

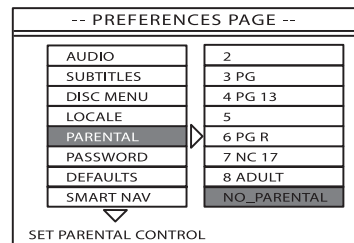

\*If a DVD does not contain the correct information, the parental control feature will not function.

## PASSWORD

### To set or change your four-digit password:

1. Highlight CHANGE and press **'enter'**. The password change page will appear.
2. Key in your old password using the digit keys on the handset (the factory set password is 3308).
3. Key in your new password, then confirm your new password.
4. When prompted on screen press **'enter'**. Your new password will now be implemented.

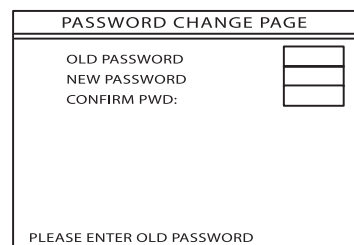

## DEFAULTS

To configure the setup menus to the original factory settings, highlight RESET and press **'enter'**.

## SMART NAV (Navigation)

See *Additional file formats* in *Playing Discs* chapter.

## Playing Discs

This chapter describes how to play DVDs and CDs on the CLASSIK Movie and explains various features and user functions.

### First of all\*

1. Turn on your TV and tune it to the CLASSIK Movie's video output signal.
2. Mute the sound from your TV.\*\*
3. Press  on the CLASSIK Movie's front panel or handset.

#### Enter DISC mode:

4. Press **DVD** on the handset. The disc display appears on the front panel.

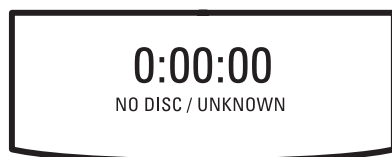

or

Repeatedly press or hold **SOURCE + / SOURCE -** on the front panel until the display shows LISTEN DISC. After a short delay, the disc display shown above appears on the front panel.

\* For listening to a CD ignore steps 1 and 2.



\*\*If you are using only your TV's speakers to hear the audio output from the CLASSIK Movie, **do not** mute the sound from your TV.

#### NOTES:

When watching a DVD if you enter a command using the front panel or handset you may see a  symbol appear on the screen. The symbol means the command is not allowed or that you must wait for the current title/chapter to finish before entering the command.















Some DVD functions may not be available on certain discs. Refer to information supplied with your DVDs.

Icons used in this chapter.

Icon	Means
	The function is for use with DVDs.
	The function is for use with CDs, CD-Rs and CD-RWs.

## Front panel display

Key to front panel display symbols:

	Play
	Pause
	Stop
	Press play to continue
	Skip to next chapter/track
	Skip to previous chapter/track
	Fast search forwards
	Fast search backwards
	Slow search forwards
	Slow search backwards
	Fast scan forwards
	Fast scan backwards
	Slow scan forwards
	Slow scan backwards
	Repeat

The display also shows time information relating to the current disc.

Repeated presses of **DISP** (display) on the handset changes the information shown, in the following sequence:

Display on front panel	Meaning
(no symbol)	Chapter/track elapsed time
—	Chapter/track remaining time
T	Total time elapsed
T —	Total time remaining



Time information for DVDs is also displayed on your TV screen. If you wish to remove the time display from your TV screen, repeatedly press **DISP** on the handset until it is not shown.

Additional disc information for DVDs and CDs is displayed on the front panel to the left and right of the time information:

### DVDs

Left of time display – Current chapter number

Right of time display – Current title number

### CDs

Left of time display – Current track number

Right of time display – Total number of tracks

## Basic operation

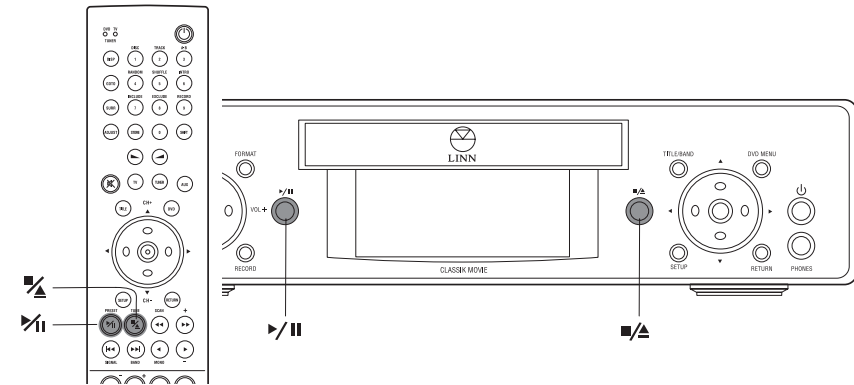

Ensure the CLASSIK Movie is in DISC mode (see *First of all*, beginning of this chapter).

### To play a disc:

- Press to open the disc drawer.
- Insert a disc with the playback side facing down.
- Press or nudge the disc drawer to close.
- If the disc is a DVD playback begins automatically. If the disc is a CD press to play the disc.

### NOTES:

Be careful not to scratch the playback surface of your discs as this can affect their performance. Be particularly careful with DVDs.

DVDs may take up to 10 seconds before they begin playing.

If the disc is a DVD a menu may appear on the TV screen (see *Using DVD menus*, this chapter).

### To pause a disc:

- Press ►/||.
- Press ►/|| again to resume playback.

### To stop playback:

- Press ■/▲.

### To stop playback and remove a disc:

- Press and hold ■/▲ until the disc drawer opens.
- Remove the disc then press ■/▲ or nudge the disc drawer to close.

### IMPORTANT:

Do not leave the disc drawer open as this allows dust into the unit.

## Locating titles/chapters/tracks on a disc

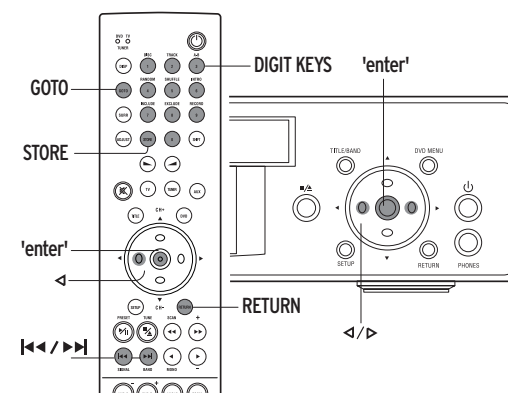

### Direct title selection



#### To directly access a title on a DVD while the menu page is showing: using the handset -

- Press **GOTO**. On your TV the digits showing the current title are highlighted.
- Enter the number of the title to be selected using the digit keys.
- Press **'enter'**.

#### To directly access a title on a DVD while a title is playing: using the handset -

- Press **GOTO**, then press ◀. On your TV the digits showing the current title are highlighted.
- Enter the number of the title to be selected using the digit keys.
- Press **'enter'**.



## Next and previous chapter/track selection



**To skip forwards or backwards through the chapters/tracks on a disc:**

**using the handset -**

- To skip forwards, hold or repeatedly press ► on the handset.
- To skip backwards, hold or repeatedly press ◀ on the handset.

**using the front panel -**

- Press 'enter' until SKIP CHAPTER or SKIP TRACK is shown on the front panel display.
- To skip forwards, hold or repeatedly press ▷.
- To skip backwards, hold or repeatedly press ◀.

## Direct chapter selection



**To directly access a specific chapter on a DVD while a title is playing:**

**using the handset -**

- Press **GOTO**. On your TV the digits showing the current chapter are highlighted.
- Enter the number of the chapter to be selected using the digit keys.
- Press 'enter'.

## Direct track selection



**To play a particular track:**

**using the handset -**

- Enter the track number using the digit keys.
- Press **STORE**, or wait for a few seconds and the track will be selected automatically.

NOTE:

A track cannot be selected if a program mode is active and the track is not included in the program (see *Include program* in this chapter).

## Replay track



**To replay the current track:**

**using the front panel or handset -**

- Press **RETURN**.

The track will play from the beginning.

## Locating a particular point on a disc

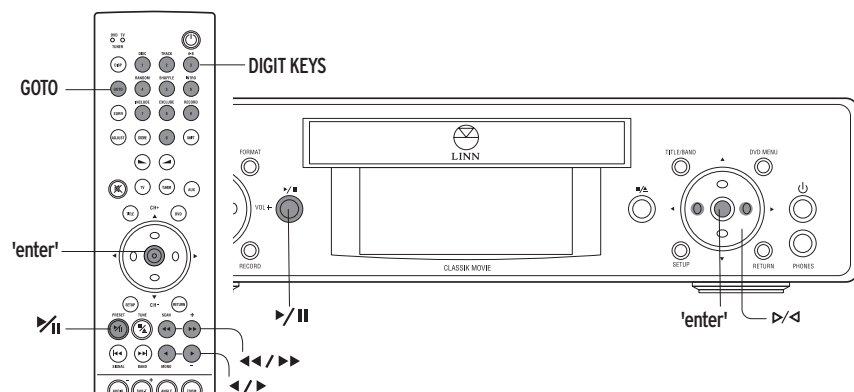

## Fast search forwards and backwards



**To perform fast search forwards or fast search reverse playback while a disc is playing:**

**using the handset -**

- To fast search forwards, hold ►►.
- To fast search backwards, hold ◀◀.

**using the front panel -**

- Repeatedly press 'enter' on the front panel until the front panel display shows FAST SEARCH.
- To fast search forwards, hold ►.
- To fast search backwards, hold ◀.

## Fast scan forwards and backwards



**To perform fast scan forwards or fast scan reverse playback while a disc is playing:**

**using the handset -**

- To fast scan forwards at 2x normal speed, press ►.

Further presses of ► increases the speed of forwards playback: 4x, 6x, 8x normal speed.  
Another press of ► returns playback to normal.

- To fast scan backwards at 2x normal speed, press ◀.

Further presses of ◀ increases the speed of reverse playback: 4x, 6x, 8x normal speed.  
Another press of ◀ returns playback to normal.

**using the front panel -**

- Repeatedly press 'enter' until the front panel display shows FAST SCAN.
- To fast scan forwards at 2x normal speed, press ►.

Further presses of ► increases the speed of forwards playback: 4x, 6x, 8x normal speed.  
Another press of ► returns playback to normal.

- To fast scan backwards at 2x normal speed, press ◀.

Further presses of ◀ increases the speed of reverse playback: 4x, 6x, 8x normal speed.  
Another press of ◀ returns playback to normal.



## Slow search forwards and backwards



To perform forwards or reverse playback one frame at a time while a DVD is playing:

### using the handset -

- Pause playback by pressing ▶/II.
- To slow search forwards, repeatedly press or hold ►►.
- To slow search backwards, repeatedly press or hold ◀◀.
- To return to normal playback, press ▶/II.

### using the front panel -

- Pause playback by pressing ▶/II.
- Repeatedly press 'enter' until the front panel display shows SLOW SEARCH.
- To slow search forwards, repeatedly press or hold ►.
- To slow search backwards, repeatedly press or hold ◀.
- To return to normal playback, press ▶/II.

## Slow scan forwards and backwards



To perform slow scan forwards or slow scan reverse playback while a DVD is playing:

### using the handset -

- Pause playback by pressing ▶/II.
- To slow scan forwards at 1/2 normal speed, press ►.

Further presses of ► decreases the speed of forwards playback: 1/4, 1/8, 1/16 normal speed.

Another press of ► returns playback to normal.

- To slow scan backwards at 1/2 normal speed, press ◀.

Further presses of ◀ decreases the speed of reverse playback: 1/4, 1/8, 1/16 normal speed.

Another press of ◀ returns playback to normal.

### using the front panel -

- Pause playback by pressing ▶/II.
- Repeatedly press 'enter' until the front panel display shows SLOW SCAN.
- To slow scan forwards at 1/2 normal speed, press ►.

Further presses of ► decreases the speed of forwards playback: 1/4, 1/8, 1/16 normal speed.

Another press of ► returns playback to normal.

- To slow scan backwards at 1/2 normal speed, press ◀.

Further presses ◀ decreases the speed of reverse playback: 1/4, 1/8, 1/16 normal speed.

Another press of ◀ returns playback to normal.



## Direct time selection



**To directly access a specific point on a DVD while a title is playing:  
using the handset -**

- Press **GOTO**. On your TV the digits showing the current chapter are highlighted.
- Press **GOTO** again.
- Enter the desired time using the digit keys. The time must be input as a six-figure number.

### EXAMPLE:

To access the point 1 hour 15 minutes and 32 seconds into playback on a DVD, press 0, 1, 1, 5, 3, 2.

The entered time is displayed on the TV.

- Press '**enter**'.

## Using program modes to control playback

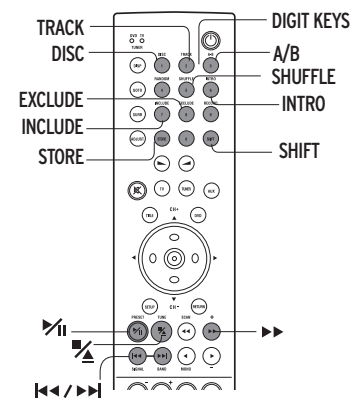

### Repeat disc



**To repeat an entire disc or DVD title:  
using the handset -**

- While the disc is playing, press **SHIFT** then press **DISC** ('1' key) within two seconds.

The front panel display shows  ALL.

When the disc/title is finished playing it will automatically play repeatedly.

### Repeat chapter/track



**To repeat a specific chapter/track:  
using the handset -**

- While the chosen chapter/track is playing, press **SHIFT** then press **TRACK** ('2' key) within two seconds.

The front panel display shows  ONE.

When the chosen chapter/track is finished playing it will automatically play repeatedly.



## Repeat section



### To repeat a specific section of a disc: using the handset -

While the disc is playing, select the start of the section to repeat -

- Press **SHIFT**, then press **A-B** ('3' key) within two seconds.

Continue playback until you reach the end of the section to repeat.

- Press **SHIFT**, then **A-B** within two seconds.

When **A-B** has been pressed for the second time, the chosen section automatically plays repeatedly.

### To cancel repeat section mode and continue with normal playback:

- Press **SHIFT**, then press **A-B** within two seconds.

TIP: (DVDs only)

For extra control over marking the start and end of a section to repeat, pause playback before pressing **SHIFT, A-B**.

## Shuffle program



Disc must be stopped before this function can be accessed.

### To shuffle the order in which tracks are played: using the handset -

- Press **SHIFT**, then press **SHUFFLE** ('5' key) within two seconds.

The front panel display shows SHUFFLE.

- Press **▶/||** to start playback.

### To cancel shuffle mode:

- Press **■/▲**.
- Press **SHIFT**, then press **SHUFFLE** within two seconds.

## Intro program



Disc must be stopped before this function can be accessed.

### To listen to the first ten seconds of each track in sequence: using the handset -

- Press **SHIFT**, then press **INTRO** ('6' key) within two seconds.

### To cancel intro playback mode and continue with normal playback:

- Press **▶/||** twice.

## Include program



This program mode allows you to select which tracks you wish to listen to from those available on a disc.

Disc must be stopped before this function can be accessed.

### To select which tracks are to be played: using the handset -

1. Press **SHIFT**, then press **INCLUDE** ('7' key) within two seconds.

The front panel display shows P01:00 and INCLUDE.

2. Use the digit keys to enter the number of the desired track.
3. Press **STORE** to store the selection and to move to the next program step.
4. Repeat steps 2 and 3 for all tracks you wish to select.
5. Press **▶/||** to store the program and start playback of the selected tracks.

### To clear a stored program or cancel include program mode:

- Press **SHIFT**, then press **INCLUDE** within two seconds.

NOTE:

Up to 99 program steps are allowed.

## Exclude program



This program mode allows you to exclude tracks from those available on a disc. Those remaining can then be played back.

Disc must be stopped before this function can be accessed.

### To select which tracks are to be excluded from playback: using the handset -

1. Press **SHIFT**, then press **EXCLUDE** ('8' key) within two seconds.

The front panel display shows P01:00 and EXCLUDE.

2. Use the digit keys to enter the number of the track you wish to exclude.
3. Press **STORE** to store the selection and to move to the next program step.
4. Repeat steps 2 and 3 for all tracks you wish to exclude.
5. Press **▶/||** to store the program and start playback of the remaining tracks.

### To clear a stored program or cancel exclude program mode:

- Press **SHIFT**, then press **EXCLUDE** within two seconds.

## Using DVD menus

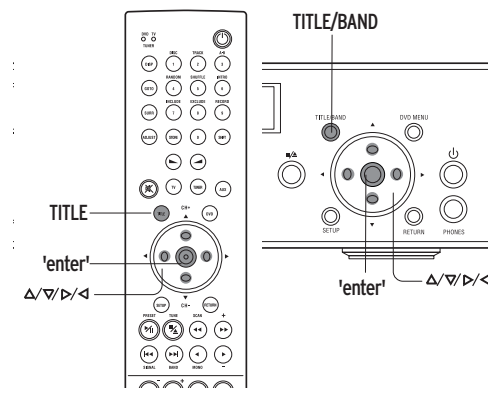

### Title/DVD menu



Many DVDs have a title menu that allows you to select which part of the DVD you wish to play or feature you wish to alter.

#### To view the title/DVD menu:

- Press **TITLE** on the handset or **TITLE/BAND** on the front panel. The title/DVD menu appears on your TV screen.
- Use **▲ / ▼ / ◀ / ▶** to select the desired title/feature.
- Press **'enter'**.



## Further playback options for DVDs

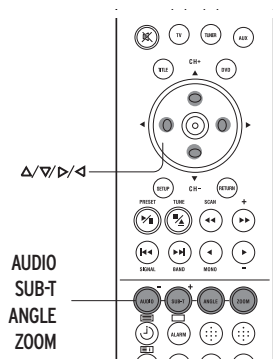

### Language selection

**To cycle through the available language options on a DVD:  
using the handset -**

- Repeatedly press **AUDIO**.

### Subtitles

**To access available subtitles:  
using the handset -**

- Press **SUB-T**.

### Angle selection

Certain DVDs allow you to view the same scene from more than one viewpoint.

**To perform angle selection:  
using the handset -**

- Press **ANGLE**.

The next available angle will be selected.

Further presses of **ANGLE** selects subsequent angles.

### Zoom and pan

Zoom allows you to view a DVD picture at different levels of magnification.  
Pan allows you to move left and right or up and down across a zoomed DVD picture.

**To perform zoom while a DVD is playing or paused:  
using the handset -**

- Press **ZOOM**.

The picture changes to the next level of magnification (1.5x normal view) and **ZOOM 1.5** is displayed on the TV.

Further presses of **ZOOM** selects greater levels of magnification: 2x, 4x normal view.  
Another press of **ZOOM** returns the picture to normal view.

**To perform pan on a zoomed picture:**

- Repeatedly press  $\Delta/\nabla/\leftarrow/\rightarrow$  on the handset.

### Surround sound and audio modes

Most DVDs have a number of surround sound formats contained on the disc. The most common formats are DTS, Dolby Digital and two-channel Dolby Digital.

Once you have selected a surround sound format via the DVD's menu, (see *Using DVD menus*, this chapter) the CLASSIK Movie allows you to further amend the audio mode in order to restrict the number of speakers used, if desired.

The options available are:

Audio mode	Speakers used
DTS Full*	Requires 5.1 channels (five full-range speakers plus subwoofer)
As Mix	As many speakers as are available (up to 6)
3 Stereo	Fronts and centre (plus subwoofer if available)
Phantom	Fronts and rears (plus subwoofer if available)
Stereo**	Fronts only (default for audio CD's)
Stereo + Sub	Fronts plus subwoofer

\* Available only for discs featuring DTS format.

\*\* If you are using only your TV speakers to hear the audio output of the CLASSIK Movie, select this mode.

### To cycle through the available audio modes:

- Repeatedly press the **SURROUND** key on the front panel or **SURR** on the handset. The audio modes are shown on the front panel display.

#### NOTES:

All above audio modes, bar DTS Full, are available when listening to a CD\* providing the Pro Logic option in the setup menus is set to ON or AUTO (see *Setup Menus* chapter).

For Dolby Digital Stereo discs you must set the Pro Logic option in the setup menus to ON or AUTO if you want to use any of the above audio modes other than Stereo and Stereo + Sub (see *Setup Menus* chapter).

### Midnight Movie mode

Midnight Movie mode functions in the same way as the Dynamic option in the setup menus; it allows you to add compression to a Dolby Digital audio signal on a DVD in order to dampen sudden increases in volume.

#### To toggle between Midnight Movie mode on or off:

- Press then hold **SURROUND** on the front panel or **SURR** on the handset.

MIDNIGHT MOVIE: ON

or

MIDNIGHT MOVIE: OFF

is displayed on the front panel for a few seconds.

#### NOTE:

Midnight Movie mode overrides the Dynamic setting in the setup menus. If the Dynamic option is set to 4/8, switching Midnight Movie mode ON adds full compression to the audio signal. If you then switch Midnight Movie mode OFF, the Dynamic setting also falls to OFF.

\* Unless the disc contains a DTS audio track.

### Additional file formats

The following file formats are also playable/viewable on the CLASSIK Movie: MP3, JPEG, MPEG 2 on data discs.

#### To play/view such files:

1. Turn on your TV and tune it to the CLASSIK Movie's video output signal.
2. Mute the sound from your TV.\*\*
3. Press  on the CLASSIK Movie's front panel or handset.
4. If the unit is not in DISC mode, press **DVD** on the handset.
5. Insert the disc into the unit. After a few seconds the SMART NAV screen appears on your TV, which shows the folder structure of the disc.

#### NOTE:

To view the contents of the disc SMART NAV in the PREFERENCES section of the setup menus must be set to MENU ON (see *Setup Menus* chapter).



6. Follow the instructions below.



Using the handset -

To navigate between sections/folders/items, use  /  /  / .

To view the contents of a folder, highlight the folder then press '**enter**'.





To play/view an item, highlight the item then press '**enter**'.

To skip forwards/backwards through items, press  / .

To fast search forwards/backwards while an MP3 or MPEG 2 file is playing, press  / .

To stop playing/viewing an item, press  / .

#### NOTE:

If SMART NAV in the setup menus is set to NO MENU, a disc inserted into the CLASSIK Movie will play from the first item of the first folder when you press '**enter**'. The , , , ,  keys will function as above.

\*\*If you are only using your TV's speakers to hear the audio output from the CLASSIK Movie, **do not** mute the sounds from your TV.



## Tuner

This chapter describes how to operate the CLASSIK Movie's tuner and explains various features and user functions.

### Setup

The first time the tuner is selected the display shown below appears on the front panel.



The CLASSIK Movie must be set for the correct radio frequency range for your country. Use the ▲/▼ keys on the handset to select your region (either Europe, USA or Japan) then press 'enter' on the handset. If you are unsure of the correct setting contact your local Linn retailer.

### First of all

1. Press on the CLASSIK Movie's front panel.

#### Enter TUNER mode:

2. Press **TUNER** on the handset. The tuner display appears on the front panel.

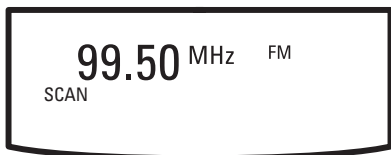

or

Repeatedly press or hold **SOURCE + / SOURCE -** on the front panel until the display shows LISTEN TUNER. After a few seconds the display will change to the tuner display above.

## Tuning functions

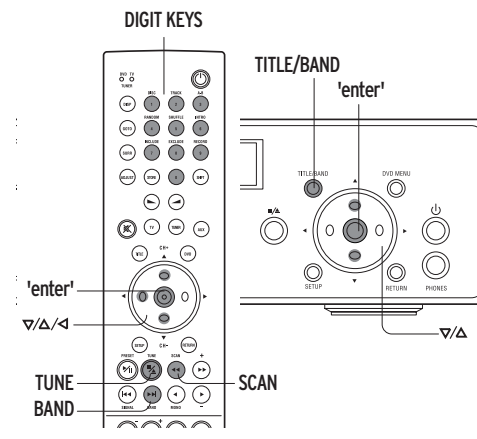

Ensure the CLASSIK Movie is in TUNER mode (see *First of all* on this page).

### AM and FM band selection

#### To toggle between AM and FM:

- Press **BAND** on the handset or **TITLE/BAND** on the front panel.

The selected band is shown on the front panel display.

### Frequency selection

#### To increase or decrease the received frequency: using the handset -

- Press **TUNE**.

TUNE is shown on the front panel display.

- To increase or decrease the frequency, repeatedly press or hold ▲/▼.
- or
- Enter a frequency using the digit keys. As you enter a frequency it is automatically adjusted to ensure it is valid. To remove an incorrect digit, press ◀.

**using the front panel or handset -**

- Repeatedly press '**enter**' until the front panel display shows TUNE.
- To increase the frequency, repeatedly press or hold ▲.
- To decrease the frequency, repeatedly press or hold ▼.

**Signal searching**

This function allows you to search up or down the AM or FM band until a signal is found.

**To search for signals:****using the handset -**

- Press and hold **SCAN** repeatedly until the front panel display shows SEARCH.
- To search for the next signal, press ▲.
- To search for the previous signal, press ▼.

**using the front panel or handset -**

- Repeatedly press '**enter**' until the front panel display shows SEARCH.
- To search for the next signal, press ▲.
- To search for the previous signal, press ▼.

**NOTE:**

The tuner skips signals that fall below the signal mute level (see *Signal mute level* next page).

**Signal scanning**

This function is the same as *Signal searching* (see left) but scanning continues automatically five seconds after a signal is found.

**To scan for signals:****using the handset -**

- Press and hold **SCAN** repeatedly until the front panel display shows SCAN.
- To scan forwards for signals, press ▲.
- To scan backwards for signals, press ▼.

**using the front panel or handset -**

- Repeatedly press '**enter**' until the front panel display shows SCAN.
- To scan forwards for signals, press ▲.
- To scan backwards for signals, press ▼.

**To terminate signal scanning:****using the front panel or handset -**

- Press **SCAN** or '**enter**'.

**NOTE:**

The tuner skips signals that fall below the signal mute level (see *Signal mute level* next page).



## Signal mute level

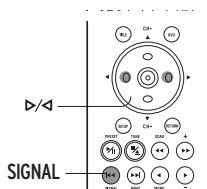

The mute level function allows you to mute the output from the tuner if the strength of a signal is below a set level.

### EXAMPLE:

If you set the mute level at 25, then the tuner will mute any received frequency that is below 25.

### To display the mute level and signal strength:

#### using the handset -

- Press **SIGNAL**.

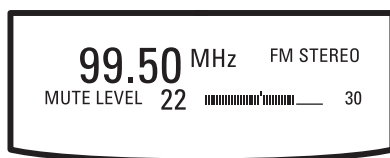

MUTE LEVEL and its value appear on the front panel display, followed by the mute level display bar.

The current signal strength appears on the far right of the display. Signal strength ranges from 0 (no signal) to 50 (strongest signal). The figure may fluctuate, reflecting the varying strength of the signal being received.

### To adjust the signal mute level:

#### using the handset -

- After pressing **SIGNAL**, to increase/decrease the signal mute level, repeatedly press or hold **▷/◀**.

Two minutes after the signal mute level has been adjusted, the display reverts to its previous display.

#### NOTE:

Signal mute level is factory-set at 15.



## Preset functions

This section explains how to store and access frequencies as presets (maximum of 200).

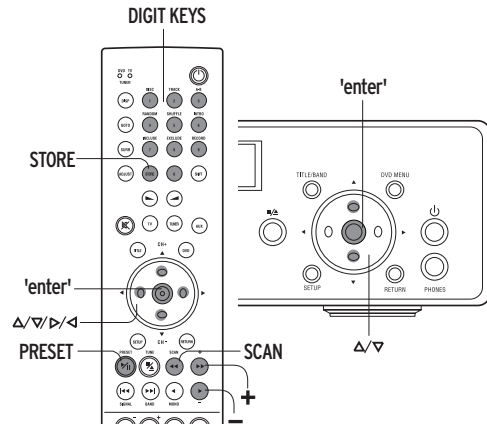

## Preset storage

**To store a frequency as a preset:  
using the handset -**

1. Set the tuner to the frequency you wish to store.
2. Press **STORE**.

The front panel display shows a flashing bar, below which is the following:

STORE: ▲ ▼ ● 0..9 ◀ ▶ - + TO EDIT

3. You are able to give each preset a name of up to 10 characters.

Enter a name using the following handset keys -

- ▲ / ▼ Cycle through A-Z, 0-9 and commonly used symbols.
- 'enter' Switches between capital and non-capital letters.
- digit keys** Can be used to quickly access numbers and A-Z in the same manner as a telephone key pad, e.g repeatedly press 2 to access A/B/C/2, or 3 to access D/E/F/3 etc.

- When you have selected the desired letter/digit/symbol press ▶ to move to the next space.

- To change or delete a character use ◀ / ▶ keys until the character flashes, then enter the new character, or press - to delete it.
- To insert a character use ◀ / ▶ keys to reach the position at which you wish to insert the new character. Press +. The flashing character and all others that follow it move one space to the right. Add the new character.

4. When you have finished entering the name for the preset, press **STORE**.

## Automatic preset storage

**To automatically scan for all available signals and store them as presets:  
using the handset -**

- Press **STORE**.
- Press **SCAN** twice. AUTOSTORE SEARCHING appears on the front panel display.

Automatic preset storage will then start at the lowest frequency and continue up to the highest frequency. As each signal is found there is a pause of 5 seconds before the frequency is stored as a preset.

- To skip the 5 second pause and store the frequency as a preset, press +. Scanning will then continue.
- To skip the 5 second pause and NOT store the frequency as a preset, press -. Scanning will then continue.

Scanning will stop automatically when the tuner reaches the highest frequency.

### NOTES:

The tuner will skip signals that fall below the signal mute level (see *Signal mute level*, this chapter).

Stored frequencies are automatically named by radio band and the order in which they are stored e.g. \_FM1, \_FM2, \_FM3 etc. The blank space allows you to personalize the preset's name. You are able to give the preset an entirely different name if you prefer (see *Preset storage* this page).

Automatic preset storage must be carried out separately for AM and FM bands.

Previously stored frequencies will not be stored again.



## Preset selection

### To select a preset:

#### using the handset -

- Press **PRESET**.

The front panel display shows PRESET.

- To select a preset, repeatedly press or hold  $\blacktriangle$  /  $\blacktriangledown$ . (Pressing  $\blacktriangle$  cycles through the presets numerically then alphabetically. Pressing  $\blacktriangledown$  reverses the order of the cycle.)

or

Press  $\blacktriangleleft$  /  $\blacktriangleright$  to select the last/first preset of each letter of the alphabet.

or

Enter the first character of the preset's name using the digit keys on the handset, remembering that digit 2 accesses any preset that begins with either A, B, C or 2, digit 3 accesses presets that begin with D, E, F or 3 etc.

The front panel display shows the preset's name.

#### using the front panel or handset -

- Repeatedly press '**enter**' until the front panel display shows PRESET.
- To move upward through the presets, repeatedly press or hold  $\blacktriangle$ .
- To move downwards through the presets, repeatedly press or hold  $\blacktriangledown$ .

## Preset deletion

### To delete a preset:

#### using the handset -

- Press **PRESET**.
- Use  $\blacktriangle$  /  $\blacktriangledown$  to select the preset you wish to delete.
- Hold **PRESET**. **PRESS ● TO CLEAR** appears on the front panel display.
- Press '**enter**'. The display shows PRESET CLEARED.

### To delete all presets:

#### using the handset -

- Press then release **PRESET**.
- Hold **PRESET** until **PRESS ● TO CLEAR** appears on the front panel display.
- Hold '**enter**' until the display shows ALL PRESETS CLEARED.

## Preamplifier

This chapter describes how to operate the CLASSIK Movie's preamplifier and explains various features and user functions.

### NOTE:

To access the preamplifier functions the CLASSIK Movie must be in one of the source modes.

## Volume and muting

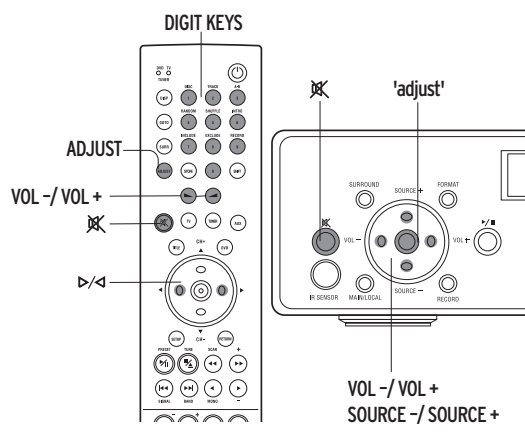

## Volume adjustment

The volume range is from 0 to 100.

### IMPORTANT:

Please note that excessive volume can damage your hearing and your audio equipment.

### To adjust the volume:

- Repeatedly press or hold **VOL - / VOL +** on the front panel or **◀ / ▶** on the handset.
- or
- Repeatedly press '**adjust**' on the front panel or **ADJUST** on the handset until the front panel shows the volume display.

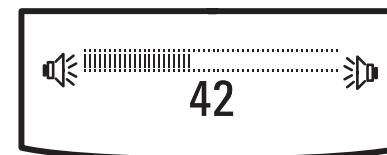

- To increase the volume, repeatedly press or hold **▶** on the handset.
- To decrease the volume, repeatedly press or hold **◀** on the handset.

### To exit from the volume display:

- Press **SOURCE+/SOURCE -** on the front panel, or the key for the current source on the handset.
- or
- Wait a few seconds for the display to revert to its previous display.

## Mute and unmute

### To mute or unmute an audio source:

- Press **⏏**.

### NOTE:

Connecting headphones to your CLASSIK Movie will automatically mute the sound to the speakers and line outputs.



## Trim adjustment

### Subwoofer trim

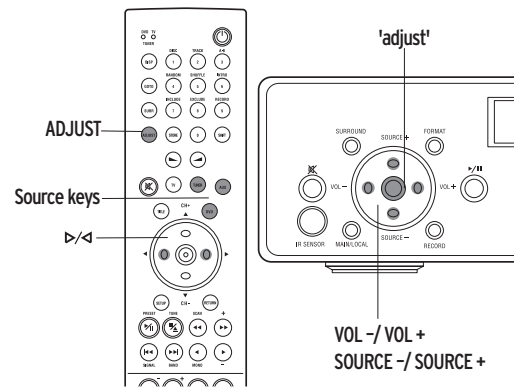

If you use a subwoofer speaker as part of your AV system, you may find that when watching a DVD or listening to a CD, you want to adjust the volume level of the subwoofer without affecting any of the other speakers. This is done by adjusting the subwoofer trim.

The subwoofer trim range is -10 to +10, with neutral trim being 0.

#### To adjust the level of subwoofer trim:

- Repeatedly press **'adjust'** on the front panel or **ADJUST** on the handset until the front panel shows the subwoofer trim display.

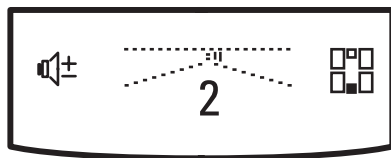

- To increase the level of trim, repeatedly press or hold **▷** on the handset or **VOL +** on the front panel.
- To decrease the level of trim, repeatedly press or hold **◀** on the handset or **VOL -** on the front panel.

#### To exit subwoofer trim adjustment:

- Press **SOURCE + / SOURCE -** on the front panel or the key for the current source on the handset.  
or
- Wait a few seconds for the display to change to the current source display.

## Centre speaker trim

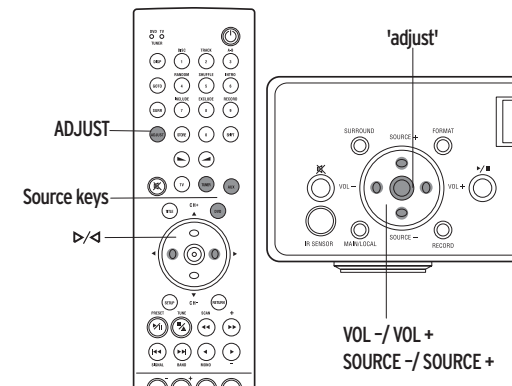

If you use a centre speaker as part of your AV/hi-fi system, you may find that when watching a DVD or listening to a CD, you want to adjust the volume level of the centre speaker without affecting any of the other speakers. This is done by adjusting the centre speaker trim.

The centre speaker trim range is from -10 to +10, with neutral trim being 0.

#### To adjust the level of centre speaker trim:

- Repeatedly press **'adjust'** on the front panel or **ADJUST** on the handset until the front panel display shows the centre speaker trim display.

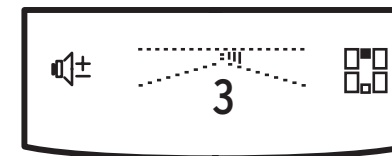

- To increase the level of trim, repeatedly press or hold **▷** on the handset or **VOL +** on the front panel.
- To decrease the level of trim, repeatedly press or hold **◀** on the handset or **VOL -** on the front panel.

#### To exit centre speaker trim adjustment:

- Press **SOURCE + / SOURCE -** on the front panel or the key for the current source on the handset.  
or
- Wait a few seconds for the display to change to the current source display.

## Balance adjustment

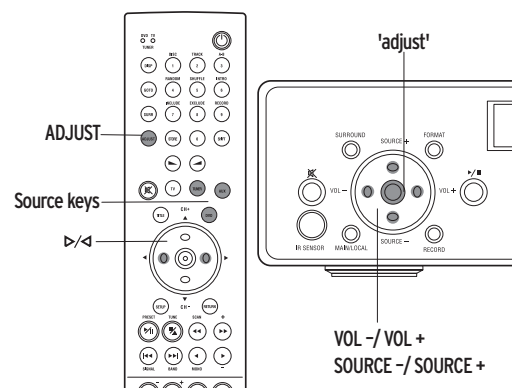

## Fader balance

This function allows you to shift the balance between the front and rear speakers.

The fader balance range is from 10 increments to the front, to 10 increments to the rear, with neutral balance being 0.

### To shift the fader balance:

- Repeatedly press **'adjust'** on the front panel or **ADJUST** on the handset until the front panel shows the fader balance display.

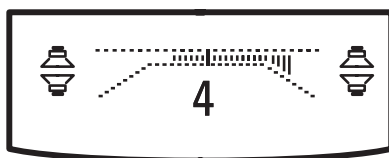

- To shift the fader balance to the front, repeatedly press or hold **▷** on the handset or **VOL +** on the front panel.
- To shift the fader balance to the rear, repeatedly press or hold **◀** on the handset or **VOL -** on the front panel.

### To exit fader balance adjustment:

- Press **SOURCE + / SOURCE -** on the front panel or the key for the current source on the handset.
- or
- Wait a few seconds for the display to change to the current source display.

### NOTE:

Shifting the fader balance will affect a centre speaker but will not affect a subwoofer.

## Master balance

This function allows you to shift the balance between the left and right speakers.

The master balance range is from 10 increments to the left, to 10 increments to the right, with neutral balance being 0.

### To shift the master balance:

- Repeatedly press **'adjust'** on the front panel or **ADJUST** on the handset until the front panel shows the master balance display.

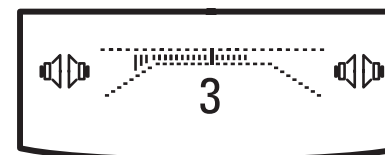

- To shift the master balance to the left, repeatedly press or hold **◀** on the handset or **VOL -** on the front panel.
- To shift the master balance to the right, repeatedly press or hold **▷** on the handset or **VOL +** on the front panel.

### To exit master balance adjustment:

- Press **SOURCE + / SOURCE -** on the front panel or the key for the current source on the handset.
- or
- Wait a few seconds for the display to change to the volume display.

### NOTE:

Shifting the master balance will not affect a centre speaker or subwoofer.



## Bass and treble adjustment

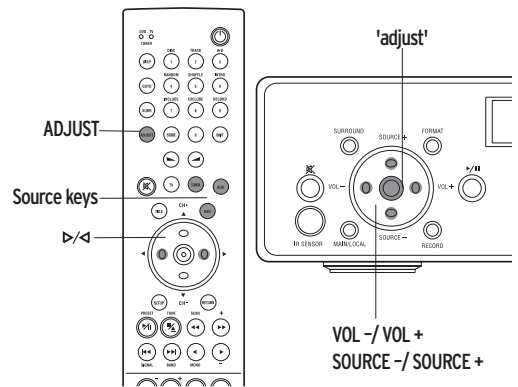

### Bass adjustment

The bass range is -7 to +7, with neutral bass being 0.

#### To adjust the level of bass:

- Repeatedly press **'adjust'** on the front panel or **ADJUST** on the handset until the front panel shows the bass display.

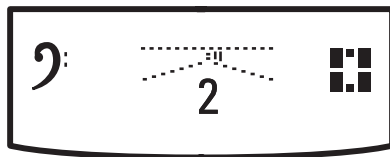

- To increase the level of bass, repeatedly press or hold **▶** on the handset or **VOL +** on the front panel.
- To decrease the level of bass, repeatedly press or hold **◀** on the handset or **VOL -** on the front panel.

#### To exit bass adjustment:

- Press **SOURCE + / SOURCE -** on the front panel or the key for the current source on the handset.
- or
- Wait a few seconds for the display to change to the current source display.

### Treble adjustment

The treble range is -7 to +7, with neutral treble being 0.

#### To adjust the level of treble:

- Repeatedly press **'adjust'** on the front panel or **ADJUST** on the handset until the front panel shows the treble display.

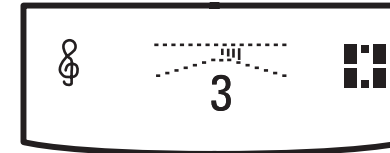

- To increase the level of treble, repeatedly press or hold **▶** on the handset or **VOL +** on the front panel.
- To decrease the level of treble, repeatedly press or hold **◀** on the handset or **VOL -** on the front panel.

#### To exit treble adjustment:

- Press **SOURCE + / SOURCE -** on the front panel or the key for the current source on the handset.
- or
- Wait a few seconds for the display to change to the current source display.

## Record Function

The record function allows you to direct a source signal to a recording device such as an audio cassette unit, VCR or DAT recorder.

### NOTE:

For reasons of copyright protection, some DVDs incorporate a protection system that prevents the recording of DVDs on to a VCR.

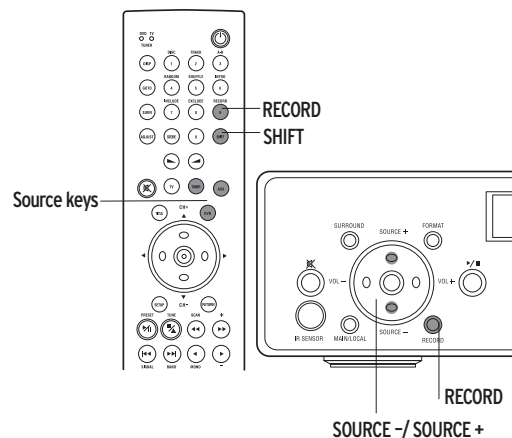

## Making a recording

### To set the source you want to record:

#### using the handset -

- Press **SHIFT**, then press **RECORD** within two seconds.
- Press the appropriate source key. For an auxiliary source, press **AUX**.

#### using the front panel -

- Press **RECORD**.
- Press or hold **SOURCE + / SOURCE -** until the desired source is shown on the front panel display.

## Record lock

The record lock is used to prevent the source you are recording being changed while a recording is in progress.

### To toggle between record lock on or off:

#### using the handset -

- Press **SHIFT**, then hold **RECORD** within two seconds until the word **LOCKED** is shown on the display (record lock ON), or is not shown on the display (record lock OFF).

#### using the front panel -

- Hold **RECORD** until the word **LOCKED** is shown on the display (record lock ON), or is not shown on the display (record lock OFF).

### NOTE:

Only the **DISC**, **TUNER** and **AUX** settings may be locked: **MAIN** and **OFF** settings cannot be locked.



## CONNECT Feature

This chapter describes how to operate the CONNECT feature, for use when two or more CLASSIK Movie units are linked together.

### About CONNECT

The CONNECT feature allows you to link a maximum of four CLASSIK Movie units (that operate as receivers), to a further CLASSIK Movie (that operates as a driver unit).

Cable connections between the driver and receiver units allow communication of front panel or handset signals, plus the feeding of the source audio signal (CD sound, tuner signal etc) from the driver to the receivers. This allows remote control of the driver unit from any of the receivers. You could, for example, listen to a CD from a receiver unit in a bedroom even though the disc itself is in the driver unit in your lounge.

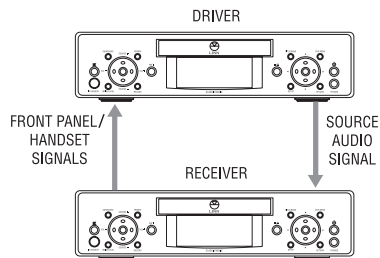

You can also control all the receiver units from the driver unit. This is a useful function when holding a party, as the same CD or radio station can be heard in up to five different rooms.

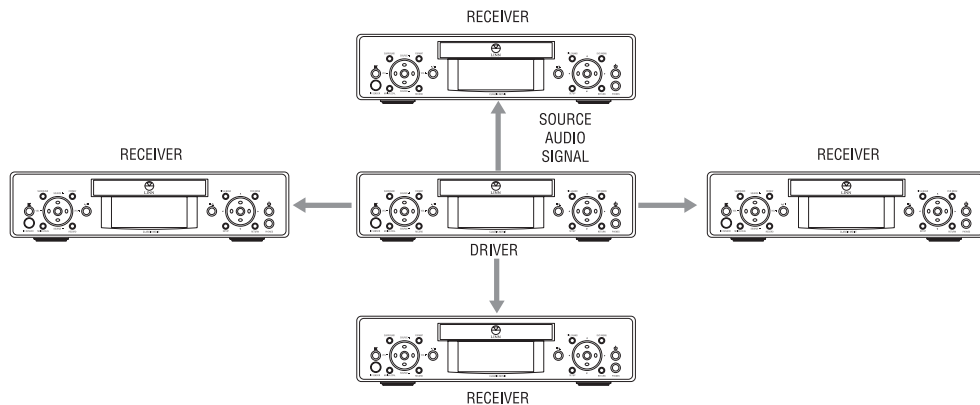

The driver and receivers can also operate as stand-alone units.

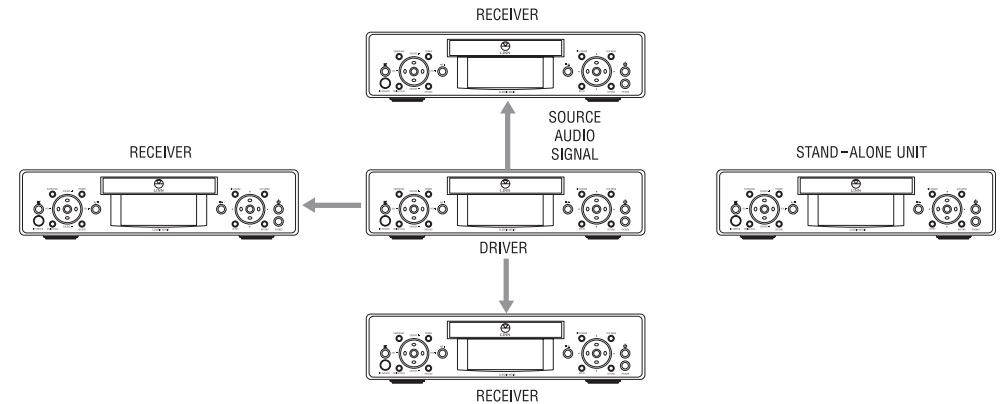

### Setting up a CONNECT system

Link the CLASSIK Movie units using CAT5 cable (available from your Linn retailer/distributor - standard computer CAT5 cable will **not** suffice).

1. Lay a suitable length of cable as you might a telephone extension (along skirting boards, around doorways), ensuring it is firmly secured to walls etc.
2. Disconnect all units from the mains supply.
3. Connect the cable to the units as shown in the diagram below.

Alternatively, have your CONNECT system installed by your local Linn retailer/distributor.

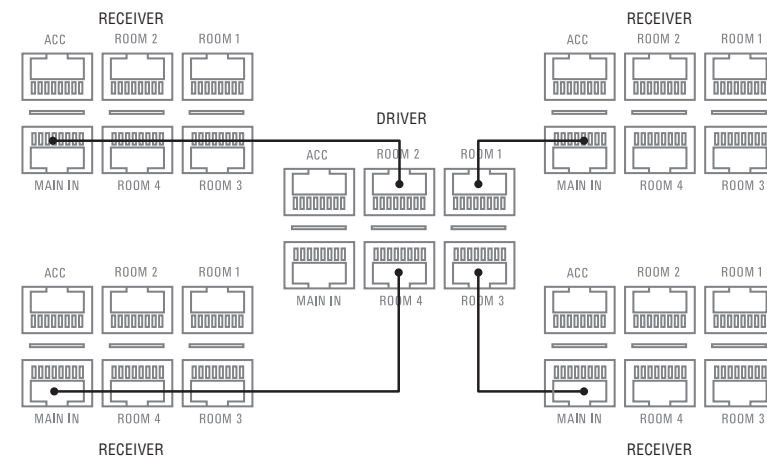

The driver unit feeds a standard stereo audio signal to the receivers, therefore a pair of suitable speakers need to be attached to each receiver in the system.



## Main Mode and Local Mode

When a CLASSIK Movie is linked into a CONNECT system as a receiver, it has two main modes of operation:

**Main Mode** - In this mode the receiver has control over the audio sources on the driver unit.

**Local Mode** - In this mode the receiver functions as a stand-alone unit.

## Switching between Main Mode and Local Mode

**To toggle between Main Mode and Local Mode on a receiver unit:**

- Press **MAIN / LOCAL** on the front panel.

The front panel displays MAIN if the unit is in Main Mode, or displays nothing if the unit is in Local Mode.

NOTES:

When in Main Mode a receiver's own sources are unavailable. This means that you cannot listen to a CD on a receiver without first switching to Local Mode.

The driver unit cannot select a receiver as a source. This means you cannot use the driver unit to listen to a CD that is playing on a receiver.

The audio signal fed from the driver to the receivers is a standard stereo signal. Surround sound modes (Pro Logic, DTS etc) are unavailable on a receiver in Main Mode.

As the driver unit always operates in Main Mode, pressing **MAIN / LOCAL** on the driver's front panel will not switch the unit to Local Mode. MAIN is not displayed on the driver's front panel.

## Controlling the driver unit from a receiver unit

When in Main Mode, a receiver can choose any audio source available on the driver unit (CD/tuner/DVD audio signal/aux. audio source) and is able to control playback of the source: you can skip through tracks on a CD, scan through the tuner's presets etc. Almost all of the functions of the CLASSIK Movie are available to you.

Only one source on the driver unit is available at any one time. This means that you cannot listen to one of the driver's tuner presets from a receiver while someone else is listening to a CD playing on the driver.

The front panel of a receiver will display the same information as the driver's front panel. Any other receivers in the system that are in Main Mode will also display the information shown on the driver's front panel.

NOTE:

A receiver unit cannot:

- control the volume of the driver unit
- mute and unmute the driver unit
- put the driver unit into standby mode.

## Party Mode

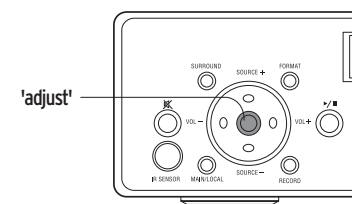

When your driver unit is in Party Mode it has limited control over the receivers. This is useful when holding a party as the same source signal (a CD, radio station etc) is fed to all the receivers.

Party Mode can only be turned on or off from the driver, however each receiver can elect to leave or join the party.



### To activate Party Mode on the driver unit:

- Press **'adjust'** on the front panel to bring up the volume display.
- Hold **'adjust'** until PARTY ON is shown on the display.

All receivers are automatically placed in Party Mode and display PARTY ON on their front panels.

#### NOTE:

When Party Mode is activated, any receivers that are in standby mode will be switched on and put into Party Mode.

### To deactivate Party Mode on the driver unit:

- Hold **'adjust'** on the front panel until PARTY OFF is shown on the display.

## Restrictions to Party Mode

When in Party Mode certain restrictions are applied (receivers are assumed to be in Main Mode):

- Changing the volume of the driver unit will also change the volume of the receivers, however changing the volume on a receiver will only affect that receiver (see next section).
- Muting will only affect the driver or receiver unit being adjusted.
- The receivers cannot change or control the source on the driver unit. If you try to change the source on the driver unit via a receiver, or press **MAIN / LOCAL** on a receiver, **\*\*PARTY\*\*** is shown on the front panel display.
- Putting the driver unit into standby mode will also put the receivers into standby and will deactivate Party Mode, whereas putting a receiver into standby will only affect that receiver.
- Bringing the driver unit out of standby and re-entering Party Mode will also bring the receivers out of standby, whereas bringing a receiver out of standby will affect that receiver only.

## Volume control in Party Mode

The driver unit can control the volume of itself and of any receivers that are in Main Mode. This allows the receivers to have different volume settings to that of the driver and to each other.

When the volume on the driver unit is changed, any difference in volume settings of the receivers remains constant. For example, suppose that volume on the driver unit is set at 40 and the receivers are set at 65. If the volume on the driver is reduced to 30, then the volume setting on the receivers will drop to 55. If the volume on the driver is reduced to 0, the volume on the receivers will drop to 25. Continuing to lower the volume on the driver will reduce the volume on the receivers to 0.

## Party Poop

Receiver units can leave a party allowing them to operate in Local Mode.

### To activate Party Poop on a receiver unit:

- Press **'adjust'** on the front panel to bring up the volume display.
- Hold **'adjust'** until the front panel displays PARTY POOP.

To rejoin the party, repeat the above steps.





## User Options

This chapter explains how you can configure certain functions of the CLASSIK Movie to suit your own requirements.

### Changing the user options' settings

**To change the user options' settings:**

**using the front panel -**

- Put unit into standby mode.
- Hold  until the display shows USER OPTIONS.
- Repeatedly press or hold  or  to select the required user option.
- Repeatedly press or hold  or  to change the setting of the user option.

**To restore a user option to its default value:**

**using the front panel -**

- Select the required user option.
- Press '**enter**'.

**To exit user options mode:**

**using the front panel -**

- Press .

The user settings are saved and the unit turns on.

### Table of user options

The following table shows the user options that are available, briefly describes them and shows the available settings for each. Default settings are shown in bold.

Option/Name	Description	Settings
Set display brightness	Allows adjustment to brightness of front panel display.	<b>100%</b> 6% - 100%
Enable source memory	On: Each source has its own volume, bass, treble, balance and fader settings. Off: All the sources use the same volume, bass, treble, balance and fader settings.	<b>On</b> Off
Enable IR sensor	Enables/disables control of the unit from the handset.	<b>On</b> Off
Set IR modulation: IR out 1	Modulation frequency for infrared flasher 1. If default is not used then the frequency is in the range 1 to 576 kHz (non-linear).	<b>36 kHz</b> 1 to 576 kHz
Set IR modulation: IR out 2	Modulation frequency for infrared flasher 2. If default is not used then the frequency is in the range 10 to 2304 kHz (non-linear).	<b>56 kHz</b> 10 to 2304 kHz
Configure ACC socket	Defines the use of the accessory socket (ACC). IR = infrared repeater RCU = KNEKT remote control unit	<b>IR</b> RCU
Configure Knekt mode	Auto: Determines whether the unit is being used in a CONNECT or KNEKT system. Main: See KNEKT documentation. Room: See KNEKT documentation.	<b>Auto</b> Main Room
Enable auto-selection: CD	If an external CD player is connected to the CLASSIK Movie and you want the CLASSIK Movie to ignore CD handset commands when it is not in DISC mode, set to Off.	<b>On</b> Off
Enable auto-selection: Tuner	If an external tuner is connected to the CLASSIK Movie and you want the CLASSIK Movie to ignore tuner handset commands when it is not in TUNER mode, set to Off.	<b>On</b> Off



## Guarantee and Service

This product is guaranteed under the conditions that apply in the country of purchase and your statutory rights are not limited. In addition to any statutory rights you may have, Linn undertake to replace any parts that have failed due to faulty manufacture. To help us, please ask your Linn retailer about the Linn warranty scheme in operation in your country.

In parts of Europe, the United States of America and some other markets, extended warranty may be available to customers who register their purchase with Linn. A warranty registration card is included with the product and should be stamped by your retailer and returned to Linn as soon as possible.

### Warning

Unauthorised servicing or dismantling of the product invalidates the manufacturers warranty. There are no user serviceable parts inside the product and all enquiries relating to product servicing should be referred to authorised retailers only.

### Technical support and information

For technical support, product queries and information, please contact either your local retailer or one of the Linn offices opposite.

Full details of your local retailer/distributor can be found on the Linn web site: [www.linn.co.uk](http://www.linn.co.uk)

### Important

- Please keep a copy of the sales receipt to establish the purchase date of the product.
- Please ensure that your equipment is insured by you during any transit or shipment for repair.

### Linn Products Limited

Floors Road  
Waterfoot  
Glasgow G76 0EP  
Scotland, UK

Phone: +44 (0)141 307 7777  
Fax: +44 (0)141 644 4262  
Helpline: 0500 888909  
Email: [helpline@linn.co.uk](mailto:helpline@linn.co.uk)  
Website: [www.linn.co.uk](http://www.linn.co.uk)

### Linn Incorporated

8787 Perimeter Park Boulevard  
Jacksonville  
FL 32216  
USA

Phone: +1 (904) 645 5242  
Fax: +1 (904) 645 7275  
Helpline: 888-671-LINN  
Email: [helpline@linninc.com](mailto:helpline@linninc.com)  
Website: [www.linninc.com](http://www.linninc.com)

### Linn Deutschland GmbH

Albert-Einstein-Ring 19  
22761 Hamburg  
Deutschland

Phone: +49-(0) 40-890 660-0  
Fax: +49-(0) 40-890 660-29  
Email: [info@linngmbh.de](mailto:info@linngmbh.de)  
Website: [www.linn.co.uk](http://www.linn.co.uk)

### Linn Japan

Kanda Northern Bldg. 4F,  
6-1-4 Sotokanda,  
Chiyoda-ku,  
Tokyo 101-0021  
Japan

Phone: +813.5816.6881  
Fax: +813.5816.6882  
Helpline: 0120 126 173  
Email: [info@linn.jp](mailto:info@linn.jp)  
Website: [www.linn-jp.com](http://www.linn-jp.com)