

LINN

English

Français

Deutsch

Italiano



UNIDISK 2.1 PLAYER
Owner's Manual

Important Safety Information

Explanation of symbols used in this manual and on the product:



This symbol is intended to alert the user to the presence of uninsulated dangerous voltages within the enclosure of sufficient magnitude to cause electric shock.



This symbol is intended to alert the user to the presence of important operation, maintenance and servicing information in the instruction and service manuals.

CAUTION

TO REDUCE THE RISK OF ELECTRIC SHOCK DO NOT REMOVE THE COVER.

NO USER SERVICEABLE PARTS INSIDE.

REFER SERVICING TO QUALIFIED SERVICE PERSONNEL.

REPLACE THE MAINS FUSE IN THE PLUG WITH ONE OF THE SAME TYPE AND RATING.

DISCONNECT SUPPLY CORD BEFORE CHANGING FUSE.

WARNING

TO REDUCE THE RISK OF FIRE OR ELECTRIC SHOCK DO NOT EXPOSE THIS APPLIANCE TO RAIN OR MOISTURE.

SHOCK HAZARD. DO NOT OPEN.

MAINS PLUGS

This appliance is supplied with a non-rewireable mains plug for the intended country.

Replacement mains leads can be obtained from your Linn retailer. Should you need to change the plug please dispose of it carefully. A plug with bared conductors is dangerous if engaged in a live socket.

The Brown wire must be connected to the Live (Line) supply pin.

The Blue wire must be connected to the Neutral supply pin.

The Green/Yellow wire must be connected to the Earth (Ground) supply pin.

Please contact your retailer or a competent electrician if you are in any doubt.

GENERAL SAFETY INSTRUCTIONS

1. **Read instructions.** Read the safety and operating instructions before operating the appliance.
2. **Retain instructions.** Retain the safety and operating instructions for future reference.
3. **Heed warnings.** Observe all warnings on the appliance and in the operating instructions.
4. **Follow instructions.** Follow all operating and use instructions.
5. **Water and moisture.** Do not use the appliance near water, for example near a bathtub, washbowl, kitchen sink, laundry tub, in a wet basement, or near a swimming pool and the like.
6. **Carts and stands.** Use only with a cart or stand that is recommended by the manufacturer.
- 6a. An appliance and cart combination should be used with care. Quick stops, excessive force, and uneven surfaces may cause the appliance and cart combination to overturn.
7. **Wall or ceiling mounting.** Mount to a wall or ceiling only as recommended by the manufacturer.
8. **Ventilation.** Site the appliance so that its location or position does not interfere with its proper ventilation. For example, the appliance should not be situated on a bed, sofa, rug, or similar surface that may block the ventilation openings, or placed in a built-in installation such as a bookcase or cabinet that may impede the flow of air through the ventilation openings.
9. **Heat.** Site the appliance away from heat sources such as radiators, heaters, stoves, or other appliances (including amplifiers) that produce heat.
10. **Power sources.** Connect the appliance to a power supply only of the type described in the operating instructions or marked on the appliance.
11. **Grounding or polarisation.** Do not defeat the safety purpose of the polarised or grounding type plug. A polarised plug has two blades with one wider than the other. A grounding type plug has two blades and a third grounding prong. The wide blade or the third prong is provided for your safety. When the provided plug does not fit into your outlet, consult an electrician for replacement of the obsolete outlet.
12. **Power cord protection.** Route power cords so that they are not likely to be walked on or pinched by items placed upon or against them, paying particular attention to cords at plugs, power sockets, and at the point where they exit from the appliance.
13. **Cleaning.** The product should be cleaned only as recommended by the manufacturer.
14. **Power lines.** An outdoor antenna should be located away from power lines.
15. **Outdoor antenna grounding.** If an outdoor antenna is connected to the tuner/receiver, ensure that the antenna system is grounded to provide some protection against voltage surges and static build up. In the USA see article 810 of the National Electrical Code ANSI/NFPA 70 concerning installation requirements.
16. **Lightning storms.** Unplug this apparatus during lightning storms or when unused for long periods of time.
17. **Objects and liquid entry.** Do not let objects or liquids fall into the product. Do not expose the product to dripping or splashing. Do not place a vessel containing liquid on top of the product.
18. **Damage requiring service.** The product should be serviced by qualified personnel if:
 - a) The power cord or plug has been damaged.
 - b) Objects or liquid have fallen into the product.
 - c) The product has been exposed to rain.
 - d) The product does not appear to operate normally or exhibits a marked change in operation.
 - e) The product has been dropped or the enclosure damaged.
19. **Servicing.** Do not attempt to service the product beyond that described in the operating instructions. All other servicing should be referred to qualified service personnel.

UK USERS PLEASE READ THIS IMPORTANT SAFETY INFORMATION

Fuse replacement

This appliance is fitted with a non-rewireable 13 Amp mains plug. The plug contains a 5 Amp fuse. If the fuse has blown it can be replaced as follows:

- Pull out the red fuse cover/carrier.
- Remove and dispose of the blown fuse.
- Fit a new 5 Amp BS1362 approved fuse into the carrier and push the carrier back into the plug.

Always ensure the fuse cover is fitted. If the fuse cover is missing do not use the plug. Contact your Linn retailer to obtain a replacement fuse cover.

Fuses are for fire protection and do not protect against electric shock.

Mains plug replacement

Should your mains plug need replacing and you are competent to do this proceed as follows. If you are in doubt contact your Linn retailer or a competent electrician.

- Disconnect the plug from the mains supply.
- Cut off the plug and dispose of it safely. A plug with bared conductors is dangerous if engaged in a live socket.
- Only fit a 13 Amp BS1363A approved plug with a 5 Amp fuse.
- The cable wire colours or a letter will be marked at the connection points of most quality plugs.

Attach the wires securely to their respective points. The Brown wire must go to the Live pin, the Blue wire must go to the Neutral pin, and the Green/Yellow wire must go to the Earth pin.

- Before replacing the plug top ensure that the cable restraint is holding the outer sheath of the cable firmly and that the wires are correctly connected.

WARNING

THIS APPLIANCE MUST BE EARTHED.

CE Declaration of Conformity

Linn Products Ltd declare that this product is in conformance with the Low Voltage Directive 73/23/EEC and Electromagnetic Compatibility 89/336/EEC as amended by 92/31/EEC and 93/68/EEC.

The conformity of the designated product with the provisions of Directive number 73/23/EEC (LVD) is proved by full compliance with the following standards:

Standard number	Date of issue	Test type
EN60065	1998	General requirements Marking Hazardous radiation Heating under normal conditions Shock hazards under normal operating conditions Insulation requirements Fault conditions Mechanical strength Parts connected to the mains supply Components Terminal devices External flexible cords Electrical connections and mechanical fixings Protection against electric shock Stability and mechanical hazards Resistance to fire

The conformity of the designated product with the provisions of Directive number 89/336/EEC (EMC) is proved by full compliance with the following standards:

Standard number	Date of issue	Test type
EN55013	2001	Conducted emissions
EN55013	2001	Absorbed emissions
EN55020	2002	Immunity

FCC notice

NOTE:

This equipment has been tested and found to comply with the limits for a Class B digital device, pursuant to Part 15 of the FCC Rules. These limits are designed to provide reasonable protection against harmful interference in a residential installation. This equipment generates, uses and can radiate radio frequency energy and, if not installed and used in accordance with the instructions, may cause harmful interference to radio communications. However, there is no guarantee that interference will not occur in a particular installation.

If this equipment does cause harmful interference to radio or television reception, which can be determined by turning the equipment off and on, the user is encouraged to try to correct the interference by one or more of the following measures:

- Reorient or relocate the receiving antenna.
- Increase the separation between the equipment and receiver.
- Connect the equipment into an outlet on a circuit different from that to which the receiver is connected.
- Consult the dealer or an experienced radio/TV technician for help.

Copyright and Acknowledgements

Copyright © 2003 Linn Products Ltd. First edition July 2003.

Linn Products Limited, Floors Road, Waterfoot, Glasgow, G76 OEP, Scotland, United Kingdom.

All rights reserved. No part of this publication may be reproduced, stored in a retrieval system, or transmitted, in any form or by any means, electronic, mechanical, photocopying, recording, or otherwise, without the prior written permission of the publisher.

Printed in the United Kingdom.

Trade marks used in this publication: **Linn** and the **Linn logo** are registered trade marks of Linn Products Limited. **UNIDISK**, **SILVER DISK ENGINE** and **KNEKT** are trade marks of Linn Products Limited.

"DVD Logo" is a trade mark of DVD Format/Logo Licensing Corporation.

"DTS" and "DTS 2+Digital Out" are trade marks of Digital Theater Systems, Inc.

Manufactured under license from Dolby Laboratories. "Dolby", "MLP Lossless" and the double-D symbol are trade marks of Dolby Laboratories.

CONSUMERS SHOULD NOTE THAT NOT ALL HIGH DEFINITION TELEVISION SETS ARE FULLY COMPATIBLE WITH THIS PRODUCT AND MAY CAUSE ARTIFACTS TO BE DISPLAYED IN THE PICTURE. IN CASE OF 525 OR 625 PROGRESSIVE SCAN PICTURE PROBLEMS, IT IS RECOMMENDED THAT THE USER SWITCH THE CONNECTION TO THE 'STANDARD DEFINITION' OUTPUT. IF THERE ARE QUESTIONS REGARDING TV SET COMPATIBILITY WITH THIS MODEL, CONTACT YOUR RETAILER.

This product incorporates copyright protection technology that is protected by method claims of certain U.S. patents and other intellectual property rights owned by Macrovision Corporation and other rights owners. Use of this copyright protection technology must be authorized by Macrovision Corporation, and is intended for home and other limited viewing uses only unless authorized by Macrovision Corporation. Reverse engineering or disassembly is prohibited.

The information in this manual is furnished for information use only, is subject to change without notice, and should not be construed as a commitment by Linn Products Limited. Linn Products Limited assumes no responsibility or liability for any errors or inaccuracies that may appear in this manual.

Linn Products Limited disclaims any proprietary interest in trade marks and trade names other than its own.

Supply of this product does not convey a license nor imply any right to distribute content created with this product in revenue-generating broadcast systems (terrestrial, satellite, cable and/or other distribution channels), streaming applications (via Internet, intranets and/or other networks), other content distribution systems (pay-audio or audio-on-demand applications and the like) or on physical media (compact discs, digital versatile discs, semiconductor chips, hard drives, memory cards and the like). An independent license for such use is required. For details, please visit <http://mp3licensing.com>

MPEG Layer-3 audio coding technology licensed from Fraunhofer IIS and Thomson.

Contents

Introduction	1		
Disc types	1		
Audio outputs	1		
Cleaning	1		
Connecting	2		
Unpacking	2		
Voltage selection	2		
Positioning	2		
Back panel	3		
Connecting the UNIDISK 2.1 to a Linn System Controller	4		
Front Panel and Handset	5		
Front panel	5		
Handset	6		
Handset modes	6		
A note for users of Linn 5103...	6		
Video Output	7		
Setup Menus	7		
About the setup menus	7		
General Setup	9		
Progressive Scan Setup	10		
Audio Setup	11		
Preferences	12		
Playing Discs	13		
First of all	13		
Front panel symbols	13		
Displayed disc information	13		
Basic operation	14		
Playing SACDs	14		
		Locating titles/chapters/tracks on a disc	15
		Direct title/chapter selection	15
		Next and previous chapter/track selection	15
		Direct chapter/track selection	15
		Direct track selection	15
		Replay chapter/track	16
		Locating a particular point on a disc	16
		Fast search forwards and backwards	16
		Fast scan forwards and backwards	16
		Slow search forwards and backwards	17
		Slow scan forwards and backwards	17
		Direct time selection	17
		Using program modes to control playback	18
		Repeat disc	18
		Repeat section	18
		Shuffle program	18
		Include program	19
		Using DVD-Video and DVD-Audio menus	19
		Further playback options for DVD-Videos	20
		Language or audio stream selection	20
		Subtitles	20
		Angle selection	20
		Zoom and pan	20
		Additional information on Video CDs and Super VCDs	21
		Additional file formats	21
		Replay file mode	22
		Shuffle mode	22
		Include program	22
		User Options	23
		Changing the user options' settings	23
		Table of user options	23
		Technical Specification	24
		Guarantee and Service	25

Introduction

The UNIDISK 2.1 player represents a new kind of source product from Linn that embodies our continuing desire to simplify access to high quality home entertainment. This unique “true convergence” product has been designed and engineered to unite all quality disk formats and offer the highest levels of performance. The product features Linn’s adaptive SILVER DISK ENGINE technology which, unlike the signal processing systems within the majority of multi-format players, allows all disc formats to be played back to their maximum potential. Practically, this means that the product delivers both music and movies to an exceptionally high standard, and it will integrate with, and improve almost any system.

Disc types

Discs marked with the following logos are compatible with your UNIDISK 2.1:

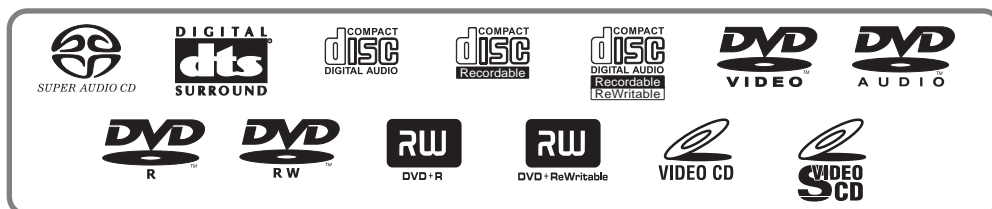

In addition, the UNIDISK 2.1 will play most copy-protected audio discs and data discs containing MP3, MPEG2 and JPEG files.

Important note

Whilst every effort has been made to ensure universal compatibility with all approved disc types, it is impossible to guarantee full operation of every function of the Linn UNIDISK 2.1 player with every disc that is on sale now or in the future. We have tested many of the disc types that are currently available but many discs that are on sale at this time do not conform to the published and accepted formal specifications. For this reason, **we are unable to accept any responsibility for the player being unable to playback any particular disc.** If you have discs that do not play on the Linn UNIDISK 2.1, which are subsequently found to play on other brands of player, then this does not imply that the Linn UNIDISK 2.1 is in any way at fault. There are many web sites that display details of discs that have known playback problems and we suggest that you consult with this published data before you make any judgments regarding the Linn UNIDISK 2.1's playback abilities. We welcome the receipt of all suspect discs as this may assist us in ensuring that the Linn UNIDISK 2.1 continues to develop but cannot accept discs from end users on the basis that we have made any warranty about being able to learn how to play them.

Novelty discs

Do not play irregularly shaped discs (heart-shaped, business card size, etc) in the UNIDISK 2.1 as they may damage the player.

Audio outputs

The audio outputs for compatible disc types are as follows:

Disc type	Digital	Analogue
SACD	None	As mix* / Stereo downmix**
DVD-Audio	None	As mix* / Stereo downmix**
DVD-Video (Dolby Surround or DTS)	As mix*	Stereo downmix**
DVD-Video (stereo)	Stereo	Stereo
CD	Stereo	Stereo
DTS CD	As mix*	Stereo downmix**
Video CD / SVCD	Stereo	Stereo

*Means as many audio channels as are present in the source material.

**Means that multi-channel source material can be downmixed to two channels.

Cleaning

Disconnect the UNIDISK 2.1 from the power supply before cleaning. Remove dust and fingerprints with a soft, dry cloth. Avoid using domestic cleaning products on the unit.

Connecting

This chapter explains how to install your UNIDISK 2.1 and how to connect it to an audio preamplifier, display devices, etc.

Note:

In this manual, 'display device' refers to plasma screens, projection TVs, monitors and televisions.

Unpacking

The UNIDISK 2.1 is supplied with the following accessories:

- luminescent handset with booklet
- 2 x RO3 (AAA) batteries for the handset
- mains lead
- 1 pair of black interconnect cables
- this manual

We recommend that you retain all packaging in case you need to transport the UNIDISK 2.1 at a later date.

Voltage selection

The UNIDISK 2.1 contains an automatic internal mains voltage switch. This switch operates on all worldwide mains voltages from 100V to 240V. Manual adjustment on the product for setting the input mains voltage is not possible.



This unit must be earthed. Use the earthed moulded mains lead supplied. Never use an unearthed plug or adaptor.

Positioning

You can position your UNIDISK 2.1 almost anywhere you find convenient, but please consider the following points:

- Allow at least 10 cm of space to the sides, rear and above the UNIDISK 2.1 for air circulation.
- You should have no problems operating the UNIDISK 2.1 with the handset wherever it is placed in a room, provided you keep your UNIDISK 2.1 out of direct sunlight.

Important:

Do not open the UNIDISK 2.1 's disc drawer if the unit is behind glass doors as this can damage the drawer's mechanism.

Back panel

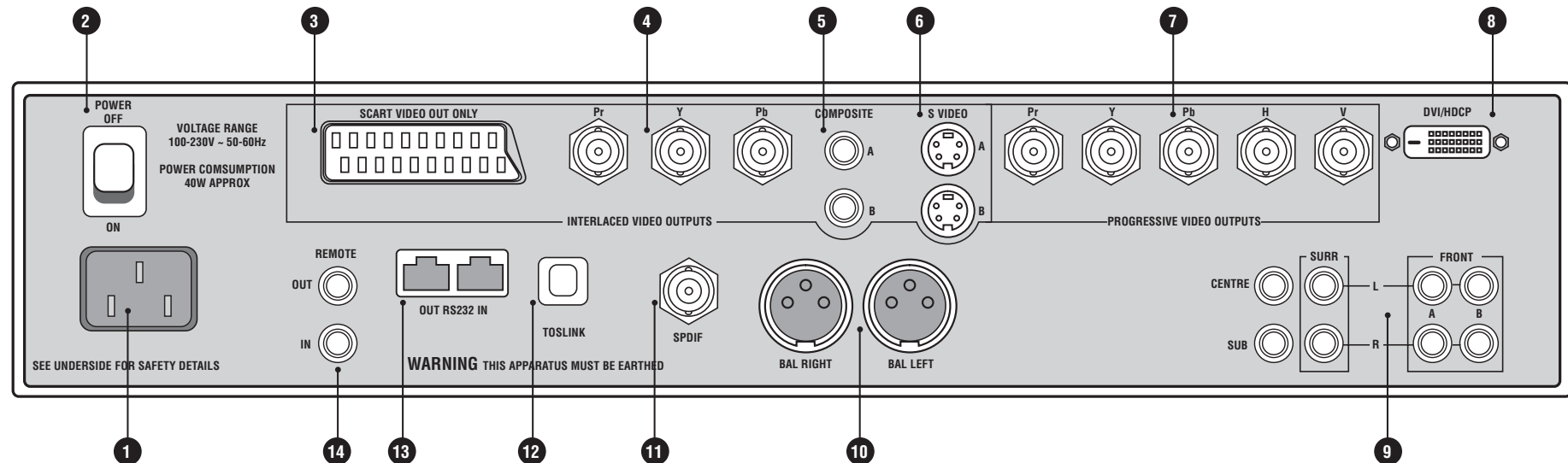

- 1** Mains input
- 2** Power switch
- 3** **SCART VIDEO OUT** For connection to the SCART socket on a display device. This connection only carries Component video. S-video and audio signals are never carried on the SCART.
- 4** **YPrPb** For connection to a display device that accepts an interlaced YPrPb signal.
- 5** **Composite** For connection to a display device that accepts a composite signal.
- 6** **S-VIDEO** For connection to a display device that accepts an S-video signal.
- 7** **YPrPbHV*** For connection to a display device that accepts a progressive video signal.
- 8** **DVI/HDCP** For connection to a display device with a DVI/HDCP digital input.
- 9** **Line output connectors** Line outputs for connection to a preamplifier.
- 10** **BAL RIGHT / LEFT** Balanced XLR outputs.

- 11** **SPDIF** For connection to a device with coaxial digital input capabilities.
- 12** **TOSLINK** For connection to a device with optical digital input capabilities.
- 13** **RS232 OUT / IN** For operating the unit via a PC or touch-screen device.
- 14** **REMOTE OUT / IN** For installing the unit in a KNEKT system.

* Due to current regulations the H and V sync outputs are not functional.

Note:

Audio signals from SACDs and DVD-Audio discs are output as analogue only. There is no output for these disc types from the digital connectors.



The UNIDISK 2.1 should be powered down then disconnected from the power supply before connecting or disconnecting any of the plugs on the back panel. If this is not done you may generate surges which could damage the UNIDISK 2.1 or other components in your AV system.

Connecting the UNIDISK 2.1 to a Linn System Controller*

The connections indicated below should be used to connect the UNIDISK 2.1 to the corresponding connections on a Linn System Controller.

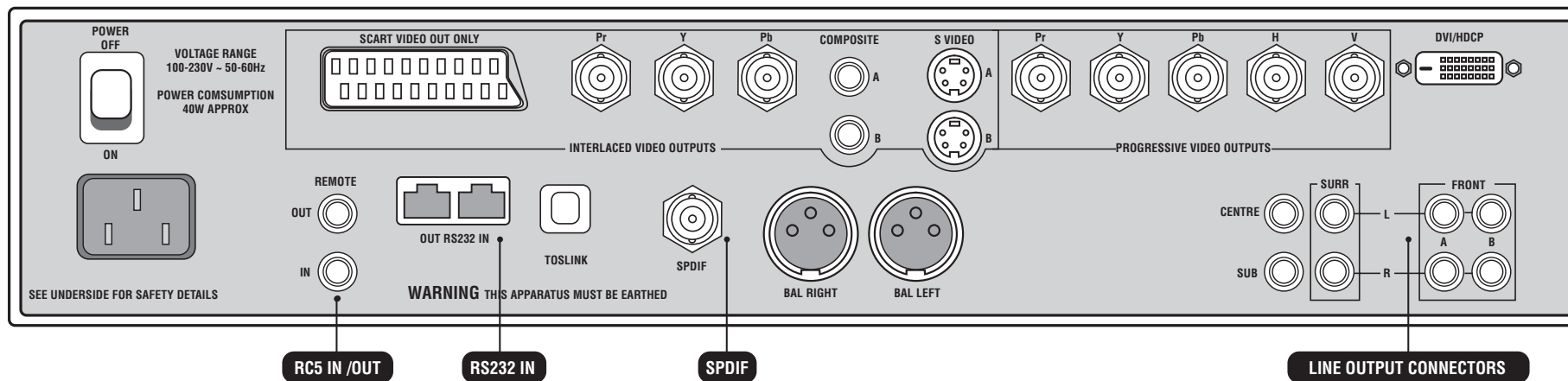

Video connections

The correct video output connections to use are governed by the type of video inputs on your display device. For example, if you want to use the YPrPb inputs on your display device, you must connect the YPrPb outputs on your UNIDISK 2.1 to the YPrPb inputs on the Linn System Controller, and the YPrPb outputs on the Linn System Controller to your display device's inputs.





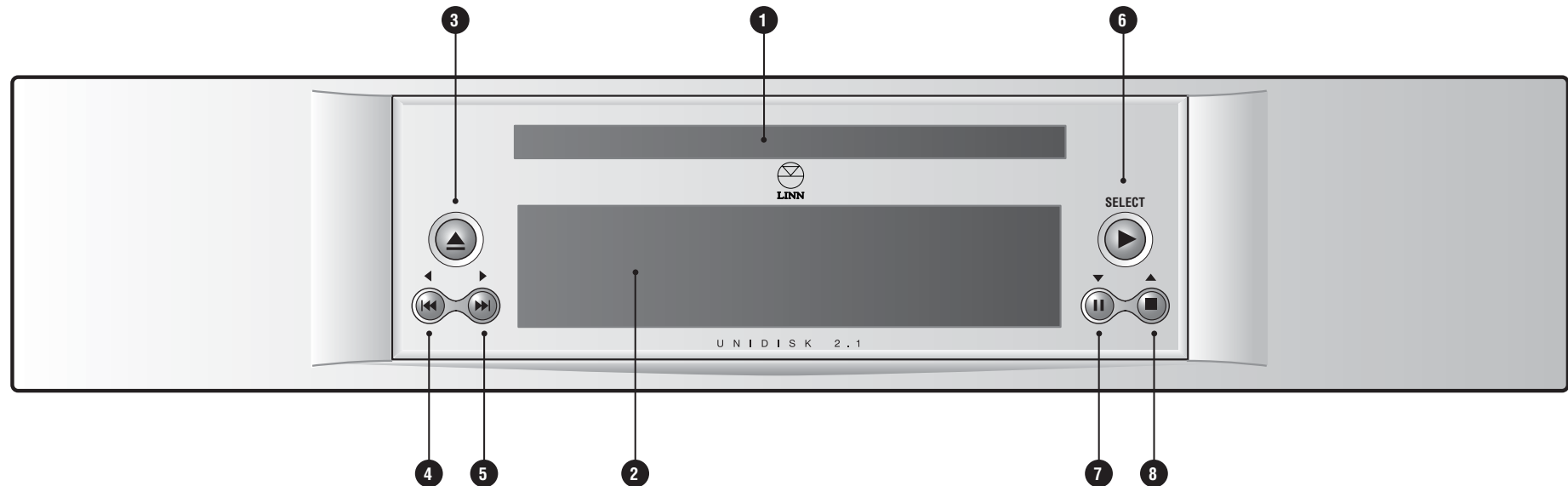

In addition to making the correct connections, certain setup menu and user option settings must be made. These are detailed in the *Setup Menus* and *User Options* chapters.

*Excluding the Linn 5103.

Front Panel and Handset

Front panel



- 1 Disc drawer
- 2 Front panel display
- 3  Opens/closes the disc drawer.
- 4  Skips/searches backwards, navigates left in a menu.
- 5  Skips/searches forwards, navigates right in a menu.
- 6  **SELECT** Starts playback, selects an item in a menu.
- 7  Pauses playback, navigates down in a menu.
- 8  Stops playback, navigates up in a menu.

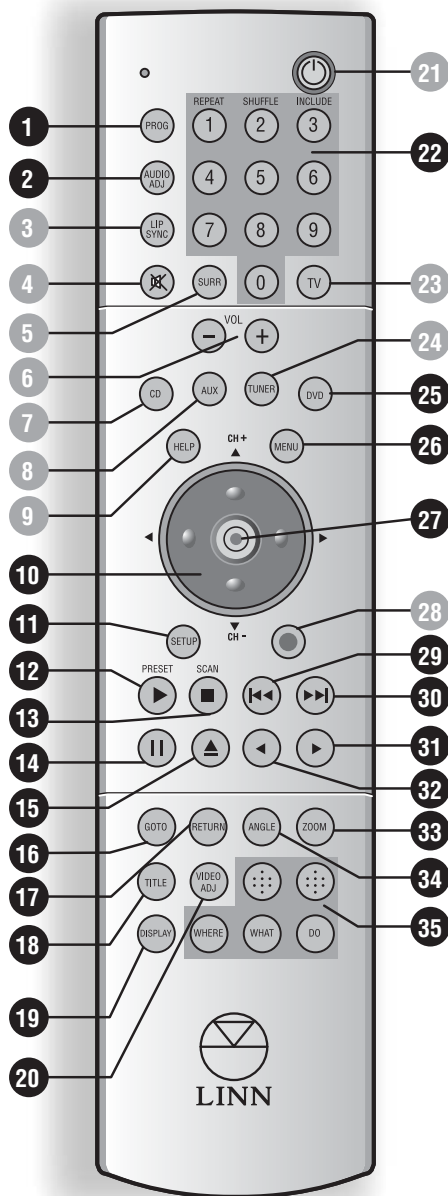

Handset

- 1 **PROG (program)** Allows access to REPEAT (digit 1), SHUFFLE (digit 2) and INCLUDE (digit 3) functions.
- 2 **AUDIO ADJ (adjust)** Cycles through available audio streams on a disc.
- 3 **LIP SYNC**
- 4 **MUTE**
- 5 **SURR**
- 6 **VOL - / +**
- 7 **CD**
- 8 **AUX**
- 9 **HELP**
- 10 **▲ ▼ ◀ ▶ / CH +, CH -** For navigating on-screen menus and adjusting settings.
- 11 **SETUP** Enters/exits on-screen setup menus.
- 12 **▶ / PRESET** Plays a disc.
- 13 **■ / SCAN** Stops a disc.
- 14 **||** Pauses a disc.
- 15 **⏏** Opens/closes the disc drawer.
- 16 **GOTO** For jumping to a particular title, chapter, track or time.
- 17 **RETURN** For navigating certain discs and for use in playing data discs.
- 18 **TITLE** For accessing disc menus or subtitles.
- 19 **DISPLAY** Changes the time display on the front panel when playing discs.
- 20 **VIDEO ADJ (adjust)** Selects video format; either PAL, NTSC or Native (automatic).
- 21 **⏻**
- 22 **Digits 0-9 / REPEAT, SHUFFLE, INCLUDE** Numeric keys / program functions.
- 23 **TV**
- 24 **TUNER**
- 25 **DVD** For selecting Disc mode.
- 26 **MENU** Enters menus on discs.
- 27 **'enter'** Executes certain commands.
- 28 **○**
- 29 **◀◀** Previous chapter/track and fast search backwards.
- 30 **▶▶** Next chapter/track and fast search forwards.
- 31 **▶** Fast scan forwards.
- 32 **◀** Fast scan backwards.
- 33 **ZOOM** Magnifies screen image.
- 34 **ANGLE** Selects available viewing angles on DVD-Videos.
- 35 **KNEKT functions** Used if the unit is installed in a KNEKT system.

Greyed keys do not function with the UNIDISK 2.1

Handset modes

Pressing a source key (DVD, CD, TUNER or AUX) on the handset will put the handset into the mode of that source. The function of the handset keys varies for the different sources, so you may find that occasionally when using the handset the UNIDISK 2.1 does not respond as expected. This is because the handset and the unit are set to different sources. To correct this, simply press the DVD key on the handset.

A note for users of Linn 5103 System Controllers and 5101 Learning Handsets

If you have connected the UNIDISK 2.1 to your 5103 System Controller and wish to operate both via your 5101 Learning Handset, assign the UNIDISK 2.1 as an auxiliary source (not as the DVD source) and then teach the 5101 the relevant UNIDISK 2.1 commands.

Video Output

In order to set up your UNIDISK 2.1, you must first ensure that the unit is outputting the correct video type for your display device.

To do this:

- Press **VIDEO ADJ** (adjust) on the handset. The current setting for the output video type is shown on the front panel display. To change the video type, press **VIDEO ADJ** again.

After a few seconds the type shown will disappear.



Setup Menus

About the setup menus

The on-screen setup menus enable you to configure your UNIDISK 2.1 to suit the picture format of your display device, audio setup and much more. It is essential that you use the setup menus to inform the UNIDISK 2.1 about components that it is connected to. Please take the time to configure your UNIDISK 2.1 correctly.

The menus are divided into four categories:

General Setup

For configuring the general audio and video setup of the unit.

Progressive Scan Setup

For configuring the progressive outputs on the unit, if used.

Audio Setup

For configuring the audio output of the unit.

Preferences

For setting up additional features such as subtitles and parental control. (This category cannot be accessed if there is a disc playing in the unit.)

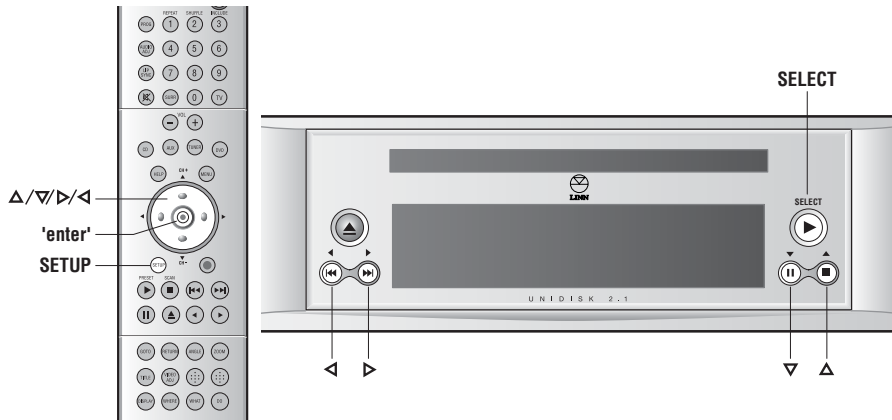

To access the setup menus:

Ensure your display device is on and tuned to the UNIDISK 2.1's video output signal.

- Press **SETUP** on the handset. Your display device screen shows the Setup Menu - Main Page.

Note:

The setup menus can be accessed when a disc is playing in the unit, unless the disc is a DVD-Audio.

To navigate the setup menus and make a selection:

- Use the $\Delta/\nabla/\leftarrow/\rightarrow$ keys on the front panel or handset to move around the menus.
- Press **'enter'** on the handset or **SELECT** on the front panel to select an option.

Example:

If you wanted to change the language used for displaying a DVD-Video menu, you would follow these steps:

- From the Setup Menu - Main Page use the ∇ key on the front panel or handset to move to the Preferences option.

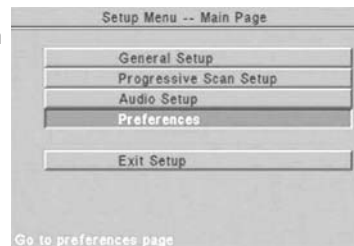
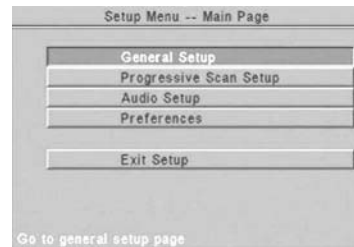

- Press **'enter'** on the front panel or **SELECT** on the handset. The Preferences Page sub-menu is displayed.

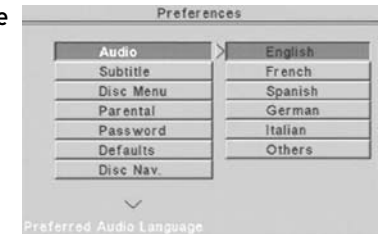

- Use the ∇ key to move to the Disc Menu option. The language options are displayed.

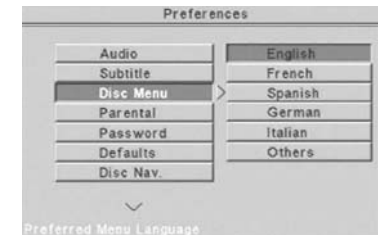

- Use the \triangleright key to move to the first language option.

- Use the ∇ key to move to the desired language. Press **'enter'** or **SELECT** to select the highlighted option.

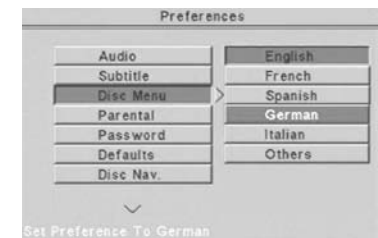

To exit from the setup menus:

- Press **SETUP** on the handset.
- or
- Use the ∇ key on the front panel or handset to highlight the Main Page option at the bottom of each sub-menu list.
- Press **'enter'** to return to the Setup Menu - Main Page.

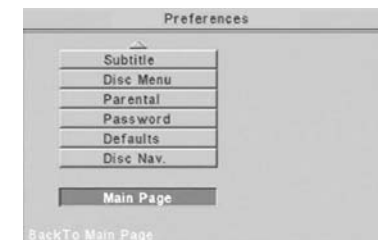

- Use the ∇ key to highlight the Exit Setup option. Press **'enter'**.

Some changes made in the setup menus will be implemented immediately. Others will be implemented after exiting setup.

General Setup

OSD Language (on-screen display language)

Default setting: **English**

Choose the language you want on-screen information and menus displayed in.



Aspect Ratio

Default setting: **16:9**

Choose the option that matches your display device; either **4:3**, **Letterbox** or **16:9**.

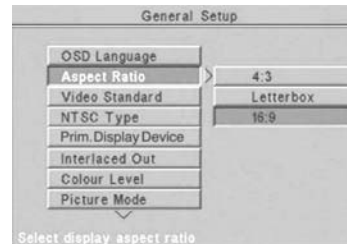

Video Standard

Default setting: **Native**

Choose the option that matches the video signal standard accepted by your display device. Set to **Native** if your display device accepts both NTSC and PAL standards.

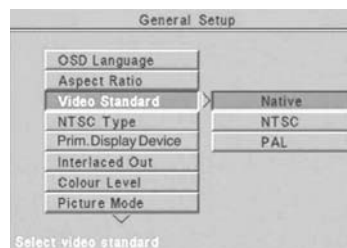

Notes:

If TV Type is set to **Native** you may notice the screen flicker when a DVD-Video begins to play. This happens when the UNIDISK 2.1 switches from one video signal standard to the other.

If your display device only accepts one type of standard, you may not be able to view DVD-Videos on the UNIDISK 2.1 that have been recorded in the other standard.

NTSC Type

For countries that use the NTSC signal standard.
Default setting: **North American**

If in the U.S.A. or Canada, set to **North American**.
If not in the U.S.A. or Canada, set to **World**.

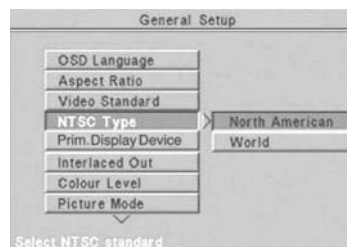

Prim. (Primary) Display Device

Default setting: **Interlaced**

The UNIDISK 2.1 is able to account for the video delay inherent in the processing required for progressive video signals, thus ensuring both video and audio signals are output simultaneously. Set this option to suit the main display device in your AV system.

Note:

If you wish to use the UNIDISK 2.1's HDCP output, your display device must be HDCP compatible. No picture will be available on a display device that has a DVI input but is not HDCP compatible.

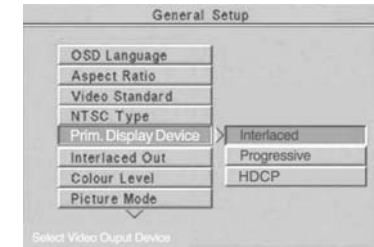

Interlaced Out

Default setting: **YPrPb**

If your display device accepts an RGB input then you must use the SCART output on the UNIDISK 2.1 and Interlaced Out must be set to **RGB**. In this situation there is no YPrPb output.

If your display device accepts a YPrPb input then you can use either the SCART or YPrPb outputs on the UNIDISK 2.1. In this case, set to **YPrPb**.



Colour Level

This option is only for use if the YPrPb interlaced outputs on the UNIDISK 2.1 are used.

Default setting: **Auto**

The Colour Level option adjusts the amount of colour information sent to your display device. If you want the UNIDISK 2.1 to determine the setting based on the video format of the disc being played, set to **Auto**.

If your display device accepts a 1V peak-to-peak input, set to **High**.
If your display device accepts a 0.7V peak-to-peak input, set to **Low**.

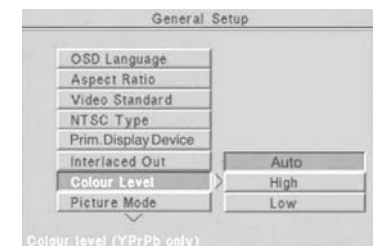

Picture Mode

Default setting: **Auto**

Due to the process of converting movies shot on film into the digital format recorded onto DVD-Videos, flickering of images can occur on a display device. The UNIDISK 2.1 offers two methods of eliminating this effect: **High resolution** and **Non-flicker**.

As the correct method is dependent on each DVD-Video, we suggest you choose the **Auto** setting which allows the UNIDISK 2.1 to select the best method for each disc.

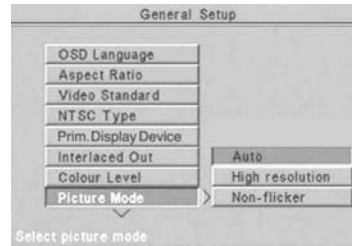

Angle Mark

Default setting: **Off**

If set to **On**, the  symbol appears on the display device to inform you when a multi-angle portion of a DVD-Video is being played. The number of available camera angles is displayed next to the symbol.



Closed Captions

Default setting: **Off**

Set to **On** to view Closed Captions (for the deaf and hard-of-hearing) that might be available on a DVD-Video.

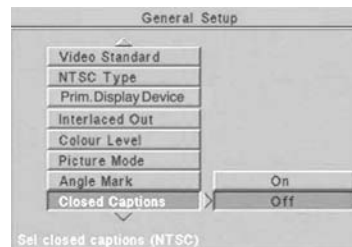

Screen Saver

Default setting: **On**

If an image is paused on your display device for too long, damage to the screen can result. Setting to **On** enables a screen saver (a blank screen) after three minutes.

Press '**enter**' to remove the screen saver.

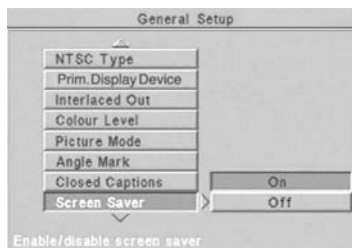

Progressive Scan Setup

These options are only for use if the progressive outputs on the UNIDISK 2.1 are used.

Colour Resolution

Default setting: **High (4:4:4)**

Setting to **High (4:4:4)** adds processing to the video signal which improves colour detail.

Setting to **Normal (4:2:2)** does not add processing.

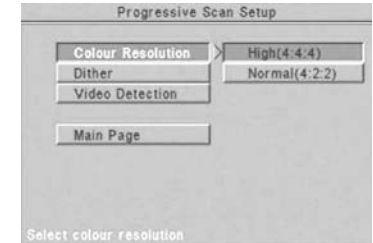

Dither

Default setting: **Off**

On display devices with limited colour depth (e.g. LCD panels) bands of colour shade rather than smooth transitions in colour shade may be seen.

Setting to **On**, reduces such colour banding.

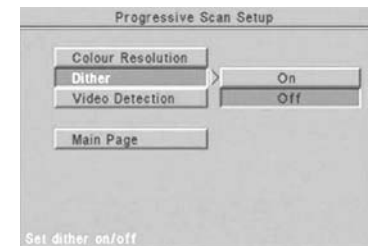

Video Detection

Default setting: **Auto**

The setting for this option is dependent on the method that was used to record the original video source material. If you want the UNIDISK 2.1 to determine the setting based on the information contained on the disc being played, set to **Auto**.

The unit functions best when set to **Auto** and should be left on that setting unless the picture on your display device appears jagged.

If the source material was recorded on film (e.g. most movies), set to **Progressive**.

If the source material was recorded on video tape (e.g. most television programmes), set to **Interlaced**.

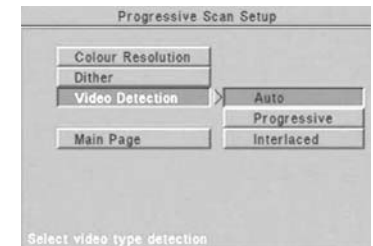

Note:

You may sometimes find that when set to **Auto** the screen image flickers. In this case choose whichever of the other two settings provides the best picture.

Audio Setup

SPDIF Out (Digital outputs only)

Default setting: **Raw**

If you are not using the UNIDISK 2.1's digital audio outputs, set to **Off**.

If any of the UNIDISK 2.1's digital outputs are connected to a Linn System Controller, other external audio decoder or other device, set to **Raw**.

If you are recording to an external digital source (e.g. DAT player), set to **LtRt PCM**.



LPCM Out (Digital outputs only)

Default setting: **LPCM 96K**

If any of the UNIDISK 2.1's digital outputs are connected to a Linn System Controller, or any other device which accepts a sampling rate of 96 kHz, set to **LPCM 96K**.

If the external device does not accept a sampling rate of 96 kHz, set to **LPCM 48K**.



Notes:

Even when set to **LPCM 96K** some discs will only output at the lower rate of 48 kHz.

Audio signals from SACDs and DVD-Audio discs are output as analogue only. There is no output for these disc types from the digital connectors.

Channel Setup (Analogue outputs only)

Default setting: **5.1 channel**

If the UNIDISK 2.1 is being used in a two channel system, set to **2 channel**. (In such a system 5.1 channel material on SACDs and DVD-Audios will be downmixed to 2 channels.)

If the UNIDISK 2.1 is connected to a Linn System Controller, or is being used in any other system that has more than two channels, set to **5.1 channel**.



Note:

Regardless of the setting Dolby Surround and DTS material is always downmixed to two channels.

Downmix (Analogue outputs only)

Default setting: **Pure Stereo**

If you are going to apply Dolby Pro Logic decoding to the audio signal, set to **LtRt**.

If you are not going to apply Dolby Pro Logic decoding to the audio signal, set to **Pure Stereo**.



Dual Mono (Analogue and digital outputs)

This option is for DVD-Videos which have separate audio tracks for the left and right channels.

Default setting: **Stereo**

To hear only the left channel, set to **L-mono**.

To hear only the right channel, set to **R-mono**.

To combine the discrete left and right channels, set to **Mix-mono**.

For normal use (i.e. most discs), set to **Stereo**.



Midnight Movie (Analogue and digital outputs)

Default setting: **Off**

This option allows you to add compression to the Dolby Digital audio signal on DVD-Videos. Adding compression reduces sudden increases in volume, such as the sound of an explosion.

To add compression, set to **On**.



Preferences

Audio*

Default setting: **English**

Set to your preferred audio language.

For languages other than the ones shown, highlight Others and press **'enter'**. Using the digit keys on the handset, enter the four-digit code for the desired language. Language codes are available at www.linn.co.uk

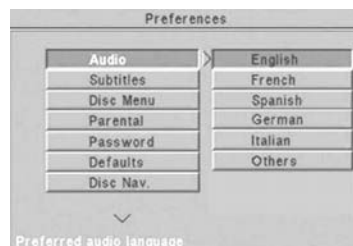

Subtitles*

Default setting: **English**

Set to your preferred subtitle language. Certain DVD-Videos will play subtitles even if this option is set to **Off**. If this happens, subtitles can be removed by pressing and holding **TITLE**.

For languages other than the ones shown, highlight Others and press **'enter'**. Using the digit keys on the handset, enter the four-digit code for the desired language. Language codes are available at www.linn.co.uk

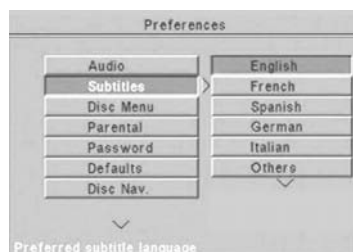

Disc Menu*

Default setting: **English**

Set to your preferred DVD-Video menu language. This option is only effective for DVD-Videos which contain a multi-language disc menu.

For languages other than the ones shown, highlight Others and press **'enter'**. Using the digit keys on the handset, enter the four-digit code for the desired language.

Language codes are available at www.linn.co.uk

* Regardless of the language selected, languages available when watching a DVD are dependent on the disc being played.

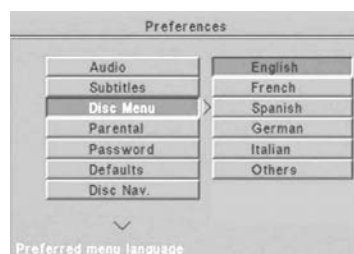

Parental

Default setting: **No Parental**

This menu allows you to program the UNIDISK 2.1 with an age restriction level for certain DVD-Videos.**

To set or change parental control:

- Highlight the desired age restriction level and press **'enter'**. The password verify page appears.
- Key in a four-digit password using the number keys on the handset (the factory-set password is 3308).
- When prompted on screen press **'enter'**.
- Exit setup to implement change.

**If a DVD-Video does not contain the correct information, the parental control feature will not function.

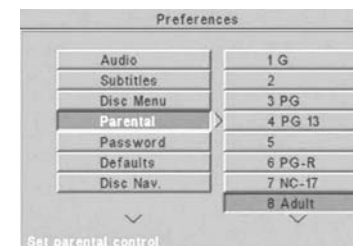

Password

Default password: **3308**

To set or change your four-digit password:

- Highlight Change and press **'enter'**. The password change page appears.
- Key in your old password using the number keys on the handset.
- Key in your new password, then confirm your new password.
- When prompted on screen press **'enter'**. Your new password will now be implemented.



Defaults

To configure the setup menus to the original factory settings, highlight Reset and press **'enter'**.

Disc Nav. (navigation)

Default setting: **Menu on**

See *Additional file formats* in the *Playing Discs* chapter.

Playing Discs

This chapter describes how to play discs on the UNIDISK 2.1 and explains various features and user functions.

First of all*

1. Turn on your display device and tune it to the UNIDISK 2.1's video output signal.
2. Mute any audio output from your display device.
3. Press **DVD** on the handset. This puts the handset into Disc mode. The handset must be in Disc mode if you want to use it for operating your UNIDISK 2.1.

*If listening to an audio disc, ignore steps 1 and 2.















Notes:

Due to variations in functionality on the various disc formats, features mentioned in this section may not be available on certain discs.

When viewing discs, if you enter a command using the front panel or handset you may see a  symbol appear on your display device. The symbol means the command is not allowed or that you must wait for the current title/chapter to finish before entering the command.

Front panel symbols

Key to symbols shown on the front panel display:

-  Play
-  Pause
-  Stop
-  Skip to next chapter/track
-  Skip to previous chapter/track
-  Fast search forwards
-  Fast search backwards
-  Slow search forwards
-  Slow search backwards
-  Fast scan forwards
-  Fast scan backwards
-  Slow scan forwards
-  Slow scan backwards
-  Repeat

Displayed disc information

The front panel display and your display device show information relating to the current disc.

Repeated presses of **DISPLAY** on the handset changes the information shown, in the following sequence:

Chapter/track elapsed
Chapter/track remaining
Title/disc elapsed
Title/disc remaining
Track name (SACDs only)

If you wish to remove the time display, repeatedly press **DISPLAY** until it is not shown.



Additional disc information is displayed on the front panel display to the left and right of the time information:

DVD-Video DVD-Audio	
Left of time display	Current title number
Right of time display	Current chapter number
CD SACD	
Left of time display	Total number of tracks
Right of time display	Current track number

A note on SACDs

SACDs show disc and track information on your display device. The amount of information shown varies from disc to disc.

Icons used in this chapter

Icon	Means
	The function is for use with DVD-Video, DVD-Audio, DVD-R, DVD-RW, DVD+R and DVD+RW discs
	The function is for use with CD, SACD, CD-R and CD-RW discs
	The function is for use with Video CD and Super VCD discs

Features or instructions specific to a particular disc format are specified.

Basic operation

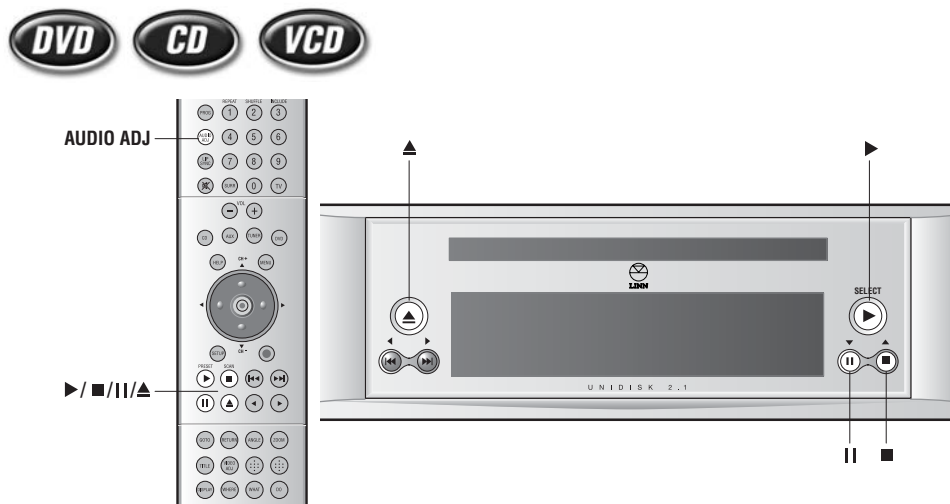

Ensure the handset is in Disc mode (see *First of all* at the beginning of this chapter).

To play a disc:

- Press ▲.
- Insert a disc with the playback side facing down.
- Press ►.
- The disc drawer closes and playback begins automatically.

Notes:

The disc drawer can be closed by nudging it. In this instance DVD-Video discs, VCDs and some DVD-Audio discs will begin playback automatically. Other disc types will not.

If the disc is a DVD-Video, DVD-Audio, VCD or SVCD a menu may appear on the display device screen (see *Using DVD-Video and DVD-Audio menus*, this chapter).

Be careful not to scratch the playback surface of your discs as this can affect their performance. Be particularly careful with DVD-Videos.

Certain types of disc may take up to 15 seconds before they begin playing.

To pause a disc:

- Press II.
- To resume playback, press ►.

To stop playback:

- Press ■.*

To remove a disc:

- Press ▲.
- Remove the disc then press ▲ or nudge the disc drawer to close.

Important:

Do not leave the disc drawer open as this allows dust into the unit.

*Playback will not stop on Video CDs or Super VCDs if PBC is turned on (see *Additional Information on Video CDs and Super VCDs*, this chapter).

Playing SACDs

SACDs can contain up to three separate areas, each of which features a different audio format. The three formats, in order of audio quality from highest to lowest are, SACD Multi (5.1 channels of high quality audio), SACD Stereo (2 channels of high quality audio) and CD Stereo (2 channels of standard CD audio).

When an SACD is inserted into the UNIDISK 2.1 the unit will default to the format that was selected the last time an SACD was played. If that area is not present on the current disc the unit will select the best format available.

You are able to select which audio format you wish to listen to from those available.

To do this:

- If the disc is playing, press ■.
- Repeatedly press **AUDIO ADJ** (adjust) on the handset until the desired format is shown on the front panel display.
- Press ►. The ► symbol on the front panel display will flash to show that the UNIDISK 2.1 has accepted the command. When the unit has selected the requested format, playback will begin.

Locating titles/chapters/tracks on a disc

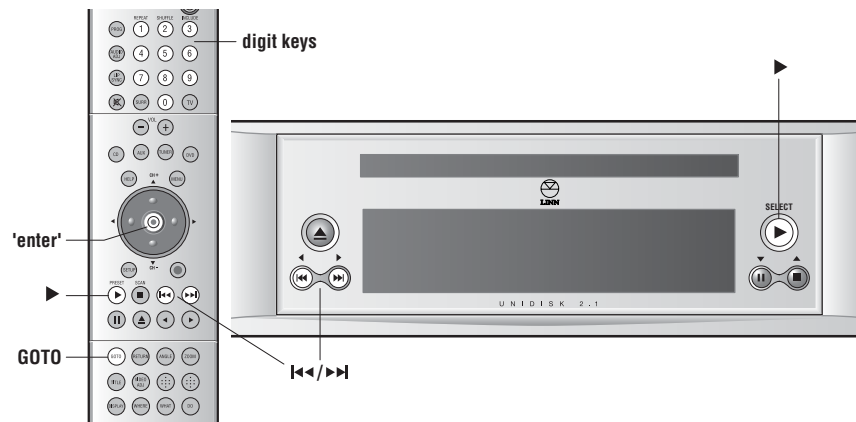

Direct title/chapter selection



To directly access a title/chapter on a disc while the menu page is showing:

- Press **GOTO** on the handset. On your display device the digits showing the current title are highlighted.
- Enter the number of the title to be selected using the digit keys.
- Press **'enter'**.

To directly access a title on a disc while a disc is playing:

- Press **GOTO** on the handset. On your display device the digits showing the current title are highlighted.
- Enter the number of the title to be selected using the digit keys.
- Press **'enter'**.

Next and previous chapter/track selection



To skip forwards or backwards through the chapters/tracks of a disc:

- To skip forwards, repeatedly press **▶▶** on the front panel or handset.
- To skip backwards, repeatedly press **◀◀**.

Direct chapter/track selection



To directly access a specific chapter on a DVD-Video or DVD-Audio while a chapter/track is playing:

- Press **GOTO** on the handset. On your display device the digits showing the current chapter/track are highlighted.
- Enter the number of the chapter/track to be selected using the digit keys.
- Press **'enter'**.

Direct track selection



To play a particular track:

- Enter the track number using the digit keys on the handset.
- Press **'enter'**, or wait for a few seconds and the track will be selected automatically.

Note:

A track cannot be selected if include program mode is active and the track is not included in the program (See *Include programme* in this chapter).

Replay chapter/track



To replay the current chapter/track:

- Press ► on the front panel or handset.

The chapter/track will play from the beginning.

Locating a particular point on a disc

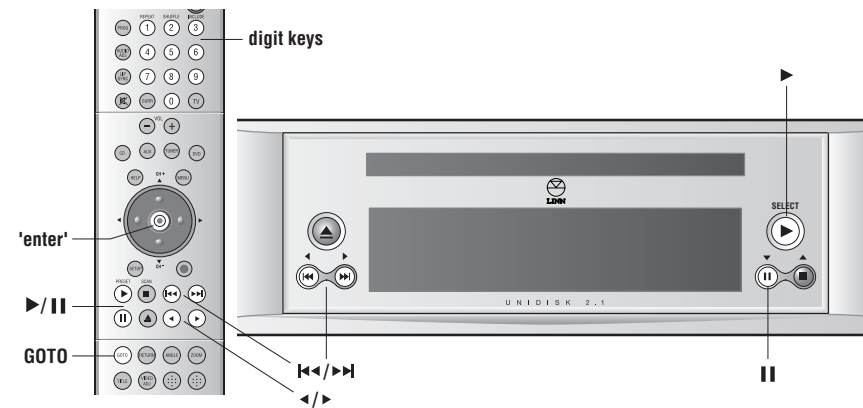

Fast search forwards and backwards



To fast search forwards or fast search backwards while a disc is playing:

- To fast search forwards, hold ►► on the front panel or handset.
- To fast search backwards, hold ◀◀.

Fast scan forwards and backwards



To fast scan forwards or fast scan backwards while a disc is playing:

- To fast scan forwards at 2x normal speed, press ► on the handset.

Further presses of ► increase the speed of forwards playback: 4x, 6x, 8x normal speed.

- Press ► to resume normal playback.

- To fast scan backwards at 2x normal speed, press ◀.

Further presses of ◀ increase the speed of reverse playback: 4x, 6x, 8x normal speed.

- Press ► to resume normal playback.

Slow search forwards and backwards



To perform forwards or reverse playback one frame at a time while a disc is playing:

- Press **II** on the front panel or handset.
- To slow search forwards, repeatedly press or hold **▶▶**.
- To slow search backwards, repeatedly press or hold **◀◀**.
- Press **▶** to resume playback.

Slow scan forwards and backwards



To perform slow scan forwards or slow scan reverse playback while a disc is playing:

- Press **II** on the handset.
- To slow scan forwards at 1/2 normal speed, press **▶·**.

Further presses of **▶·** decrease the speed of forwards playback: 1/4, 1/8, 1/16 normal speed.

- Press **▶** to resume normal playback.
- To slow scan backwards at 1/2 normal speed, press **◀·**.

Further presses of **◀·** decrease the speed of reverse playback: 1/4, 1/8, 1/16 normal speed.

- Press **▶** to resume normal playback.

Direct time selection



To directly access a specific point on a DVD-Video or DVD-Audio while a chapter/track is playing:

- Press **GOTO** on the handset. On your display device the digits showing the current chapter are highlighted.
- Press **GOTO** again.
- Enter the desired time using the digit keys. The time must be input as a six-figure number.

Example:

To access the point 1 hour 15 minutes and 32 seconds into playback, press 0, 1, 1, 5, 3, 2. The entered time is shown on the display device.

- Press **'enter'**.

Using program modes to control playback

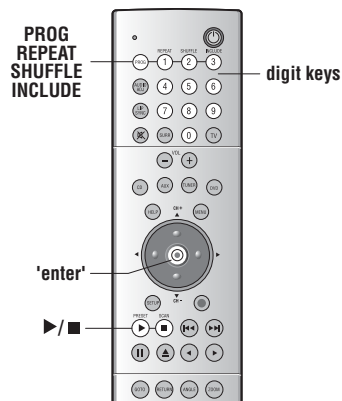

Repeat disc



To repeat an entire DVD-Video title, DVD-Audio group or CD:

- While the disc is playing, press **PROG** on the handset, then press and hold **REPEAT** ('1' key) within two seconds.

The front panel display shows ALL.

- Release **REPEAT**.

When the title/group/disc is finished playing it will automatically play repeatedly.

To cancel repeat disc mode:

- While the disc is playing, press **PROG**, then press and hold **REPEAT** ('1' key) within two seconds.

ALL disappears from the display.

- Release **REPEAT**.

Repeat section



To repeat a specific section of a disc:

- At the start of the section you wish to repeat, press **PROG** on the handset, then press **REPEAT** briefly ('1' key) within two seconds. 'A' appears on the front panel display.
- Continue playback until you reach the end of the section to repeat.
- Press **PROG**, then **REPEAT** briefly within two seconds. 'B' appears on the front panel display.

After **REPEAT** has been pressed for the second time, the chosen section automatically plays repeatedly.

To cancel repeat section mode and continue with normal playback:

- Press **PROG**, then press **REPEAT** within two seconds.

Shuffle program



Disc must be stopped before this function can be accessed.

To shuffle the order in which tracks are played:

- Press **PROG** on the handset, then press **SHUFFLE** ('2' key) within two seconds.

The front panel display shows SHF (shuffle).

- Press ▶ to start playback.

To cancel shuffle mode:

- Press ■.
- Press **PROG**, then press **SHUFFLE** within two seconds.

Include program



This program mode allows you to select which chapters/tracks you wish to listen to from those available on a disc.

Disc must be stopped before this function can be accessed.

To select which tracks are to be played:

1. Press **PROG** on the handset, then press **INCLUDE** ('3' key) within two seconds.

The front panel display shows P01:00 and INC (include).

2. Use the digit keys to enter the number of the desired track.
3. Press **'enter'** to store the selection and to move to the next program step.
4. Repeat steps 2 and 3 for all tracks you wish to select.
5. Press **▶** to store the program and start playback of the selected tracks.

To clear a stored program or cancel include program mode:

- Press **PROG** on the handset, then press **INCLUDE** within two seconds.

Note:

Up to 99 program steps can be stored.

Using DVD-Video and DVD-Audio menus

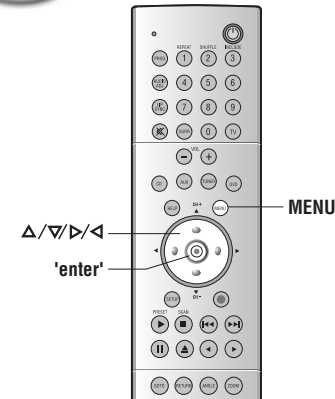

Most DVD-Video and DVD-Audio discs have one or more menus that allows you to select which part of the disc you wish to play, or feature you wish to view or alter.

To navigate menus:

- Press **MENU** on the handset. The menu appears on your display device screen.
- Use **▲/▼/◀/▶** to select the desired title/feature.
- Press **'enter'**.

Further playback options for DVD-Videos and DVD-Audios

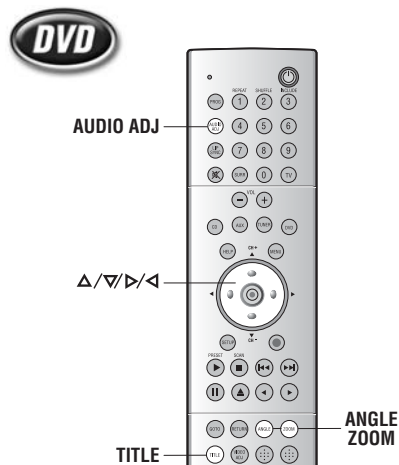

Language or audio stream selection

To cycle through the available language or audio stream options:

- Repeatedly press **AUDIO ADJ** on the handset.

Subtitles

To access available subtitles on DVD-Videos:

- Repeatedly press and hold **TITLE** on the handset.

Angle selection

Certain DVD-Videos allow you to view the same scene from more than one viewpoint.

To perform angle selection:

- Press **ANGLE** on the handset.

The next available angle will be selected.

Further presses of **ANGLE** select subsequent angles.

Zoom and pan

Zoom allows you to view a picture at different levels of magnification.

Pan allows you to move left and right or up and down across a zoomed picture.

To perform zoom while a disc is playing or paused:

- Press **ZOOM** on the handset.

The picture changes to the next level of magnification (1.5x normal view) and **ZOOM 1.5** is shown on the display device.

Further presses of **ZOOM** select greater levels of magnification: 2x, 3x normal view. Another press of **ZOOM** returns the picture to normal view.

To perform pan on a zoomed picture:

- Repeatedly press or hold **▲/▼/◀/▶** on the handset.

Additional information on Video CDs and Super VCDs

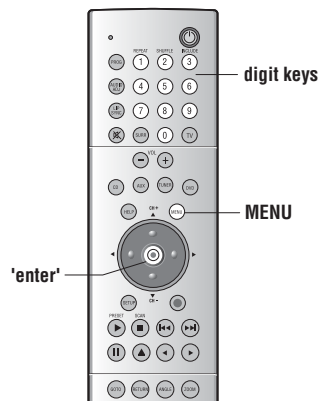

Video CDs and Super VCDs may feature PBC (Playback Control). PBC allows additional control over playback functionality. PBC can be turned on or off to suit your requirements. If PBC is on you will be able to pause the disc and skip forwards or backwards through tracks.

Additionally, with Super VCDs, a menu showing the contents of the disc will appear on your display device. To play a specific track, press the appropriate digit key then press 'enter'.

If PBC is off, such functionality may not be available.

To turn PBC on or off:

- Press **MENU** on the handset.

Additional file formats

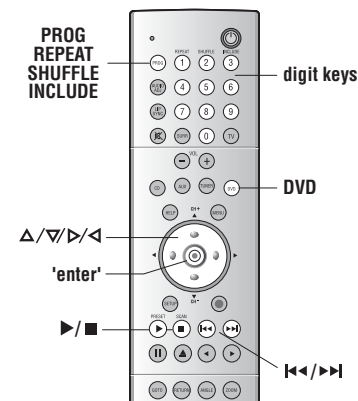

The following file formats, if recorded on data discs, are playable/viewable on the UNIDISK 2.1: MP3, JPEG, MPEG2.

To play/view such files:

- Turn on your display device and tune it to the UNIDISK 2.1's video output signal.
- If the handset is not in Disc mode, press **DVD**.
- Insert the data disc into the UNIDISK 2.1. After a few seconds the Disc Navigation screen appears on your display device, which shows the folder structure of the disc.

Note:

To view the contents of the data disc, Disc Nav. in the Preferences section of the setup menus must be set to **Menu On** (see *Setup Menus* chapter).

Follow the instructions below.

- To navigate between sections, folders or items, use $\Delta / \nabla / \triangleleft / \triangleright$ on the handset.
- To view the contents of a folder, highlight the folder then press 'enter'.
- To play/view an item, highlight the item then press 'enter'.
- To skip forwards/backwards through items, press $\triangleright / \triangleleft$.

- To fast search forwards/backwards while an MP3 or MPEG 2 file is playing, press and hold ►► / ◀◀.
- To stop playing/viewing an item, press ■.

Note:

If Disc Nav. in the setup menus is set to **Menu Off**, a data disc inserted into the UNIDISK 2.1 will play from the first item of the first folder when you press 'enter'. The ►► / ◀◀ / ■ keys will function as above.

Replay file mode

To replay an MP3 file:

- While the file is playing, press **PROG** on the handset, then press **REPEAT** ('1' key) within two seconds.

The front panel display shows ONE.

To cancel replay file mode:

- Press **PROG**, then press **REPEAT** within two seconds.

Shuffle mode

To shuffle the order in which files in a folder play:

- While the first file is playing, press **PROG** on the handset, then press **SHUFFLE** ('2' key) within two seconds.

The front panel display shows SHF.

To cancel shuffle mode:

- Press **PROG**, then press **SHUFFLE** within two seconds.

Include program

This mode allows you to select which files you wish to listen to/view from those available in a folder.

To select which files are to be played:

1. Press **PROG** on the handset, then press **INCLUDE** ('3' key) within two seconds.

The front panel display shows P01:00 and INC (include).

2. Use the digit keys to enter the number of the desired file.
3. Press 'enter' to store the selection and to move to the next program step.
4. Repeat steps 2 and 3 for all files you wish to select.
5. Press ► to store the program and start playback of the selected files.

To clear a stored program or cancel include program mode:

- Press **PROG** on the handset, then press **INCLUDE** within two seconds.

User Options

This chapter explains how you can configure certain functions of the UNIDISK 2.1 to suit your own requirements.

Changing the user options' settings

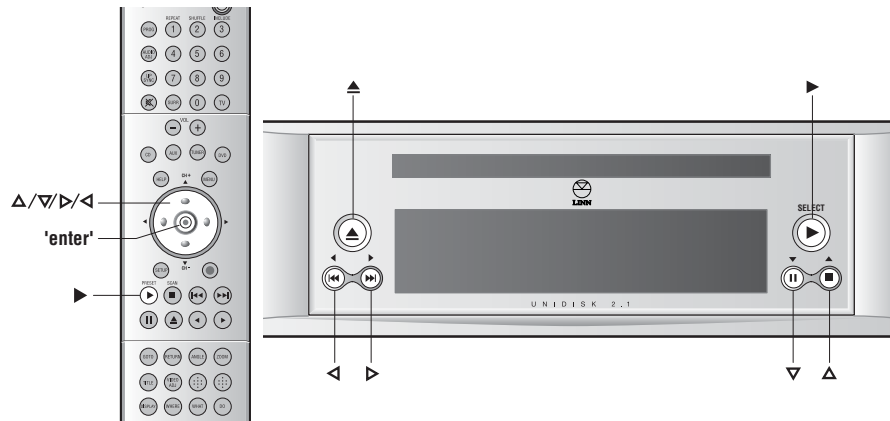

To enter the user options' settings:

- If there is a disc in the unit, remove it, close the disc drawer and wait for the front panel display to read NO DISC.
- Hold ▲ on the front panel until the display shows User Options.

To change the user options' settings:

- Repeatedly press or hold ▲ or ▼ on the front panel or handset to select the required user option.
- Repeatedly press or hold ► or ◀ to change the setting of the user option.

To restore a user option to its default value:

- Select the required user option.
- Press 'enter' on the handset.

To save settings and exit user options mode:

- Press ► on the front panel or handset.

Table of user options

The following table shows the UNIDISK 2.1's user options, briefly describes them and lists the available settings for each. Default settings are shown in bold (and are marked with a '*' on the front panel display).

Option	Description	Settings
Display brightness	Allows adjustment to the brightness of the front panel display. When set to AUTO, the unit will select a brightness level based on the ambient light level in the room (the greater the ambient light level, the brighter the display will be).	AUTO 2% to 100% (non-linear)
Sleep display delay	Sets the number of seconds that the unit is inactive for, before the sleep display (three dots) is shown on the front panel.	OFF 0m 10s to 5m 00s (in 10 sec steps)
Front panel IR command	If set to ACCEPTED, unit will respond to commands received via the IR receiver on the front panel.	ACCEPTED IGNORED
Pass IR to REMOTE OUT	If set to ENABLED, passes commands received via the IR receiver on the front panel to REMOTE OUT. Will function even if the 'Front panel IR command' option is set to IGNORED.	ENABLED DISABLED
Pass REMOTE IN to OUT	If set to ENABLED, passes RC5 commands received at REMOTE IN to REMOTE OUT.	ENABLED DISABLED
RS232 baudrate	Sets the baudrate for RS232 control.	9600 4800 to 230400 (8 settings)
RS232 events	If set to ENABLED, passes information regarding the internal status of the unit to an external device that accepts RS232 data.	ENABLED DISABLED
RS232 startup message	If set to ENABLED, will output an RS232 start message when the unit is switched on.	ENABLED DISABLED
CD commands	If an external CD player is connected to the UNIDISK 2.1 and you want the UNIDISK 2.1 to ignore CD handset commands, set to IGNORED.	ACCEPTED IGNORED
Scroll SACD text	ONCE: Track information on SACDs will scroll once across the front panel display. LOOP: Track information on SACDs will scroll repeatedly across the front panel display. NO: Track information on SACDs will not appear on the front panel display.	ONCE LOOP NO

Technical Specification

Electrical	
Mains voltage	100-230 VAC @ 50-60 Hz
Power consumption	40 W approximately
Physical	
Weight	4.8 kg
Dimensions	380 (W) x 360 (D) x 80 (H) mm

Signal Interfaces				
Interlaced video				
Type	Connector	Level	Impedance	Notes
Component	SCART	RGB + Composite : 1 Vp-p	75 Ω	No audio on the SCART
	3 x BNC	Y : 1 Vp-p	75 Ω	-
		Pr : 1 Vp-p (switchable to 700 mVp-p) Pb : 1 Vp-p (switchable to 700 mVp-p)		
Composite	2 x RCA	1 Vp-p	75 Ω	-
S-video	2 x 4 pin mini-DIN	Y (lum) : 1 Vp-p	75 Ω	-
		C (chr) : 700 mVp-p	75 Ω	-
Progressive scan video				
Type	Connector	Level	Impedance	Notes
Component	3 x BNC	Y : 1 Vp-p	75 Ω	-
		Pr : 1 Vp-p (switchable to 700 mVp-p)		
		Pb : 1 Vp-p (switchable to 700 mVp-p)		

Signal Interfaces				
Analogue audio				
Type	Connector	Level	Impedance	Notes
Unbalanced	8 x RCA	2 Vrms	300 Ω	Front L(A), L(B), R(A), R(B) Rear L and R Centre and Sub
Balanced	2 x male XLR	4 Vrms	600 Ω	Front L and R (pin1 gnd, pin 2 hot, pin 3 cold)
Digital audio				
Type	Connector	Level	Impedance	Notes
SPDIF	BNC	500 mVp-p	75 Ω	Electrical
	TOSLINK	-	-	Optical
Data & control				
Type	Connector	Level	Impedance	Notes
RS232	2 x RJ11	-	-	-
Remote In/Out	2 x RCA	4 mA	-	For KNEKT use only

Guarantee and Service

This product is guaranteed under the conditions that apply in the country of purchase and your statutory rights are not limited. In addition to any statutory rights you may have, Linn undertake to replace any parts that have failed due to faulty manufacture. To help us, please ask your Linn retailer about the Linn warranty scheme in operation in your country.

In parts of Europe, the United States of America and some other markets, extended warranty may be available to customers who register their purchase with Linn. A warranty registration card is included with the product and should be stamped by your retailer and returned to Linn as soon as possible.

Warning

Unauthorised servicing or dismantling of the product invalidates the manufacturers warranty. There are no user serviceable parts inside the product and all enquiries relating to product servicing should be referred to authorised retailers only.

Technical support and information

For technical support, product queries and information, please contact either your local retailer or one of the Linn offices opposite.

Full details of your local retailer/distributor can be found on the Linn web site: www.linn.co.uk

Important

- Please keep a copy of the sales receipt to establish the purchase date of the product.
- Please ensure that your equipment is insured by you during any transit or shipment for repair.

Linn Products Limited

Floors Road
Waterfoot
Glasgow G76 OEP
Scotland, UK

Phone: +44 (0)141 307 7777
Fax: +44 (0)141 644 4262
Helpline: 0500 888909
Email: helpline@linn.co.uk
Website: www.linn.co.uk

Linn Incorporated

8787 Perimeter Park Boulevard
Jacksonville
FL 32216
USA

Phone: +1 (904) 645 5242
Fax: +1 (904) 645 7275
Helpline: 888-671-LINN
Email: helpline@linninc.com
Website: www.linninc.com

Linn Deutschland GmbH

Albert-Einstein-Ring 19
22761 Hamburg
Deutschland

Phone: +49-(0) 40-890 660-0
Fax: +49-(0) 40-890 660-29
Email: info@linngmbh.de
Website: www.linn.co.uk

Linn Japan

Kanda Northern Bldg. 4F,
6-1-4 Sotokanda,
Chiyoda-ku,
Tokyo 101-0021
Japan

Phone: +813.5816.6881
Fax: +813.5816.6882
Helpline: 0120 126 173
Email: info@linn.jp
Website: www.linn-jp.com