

LINN

English

Français
Deutsch
Italiano

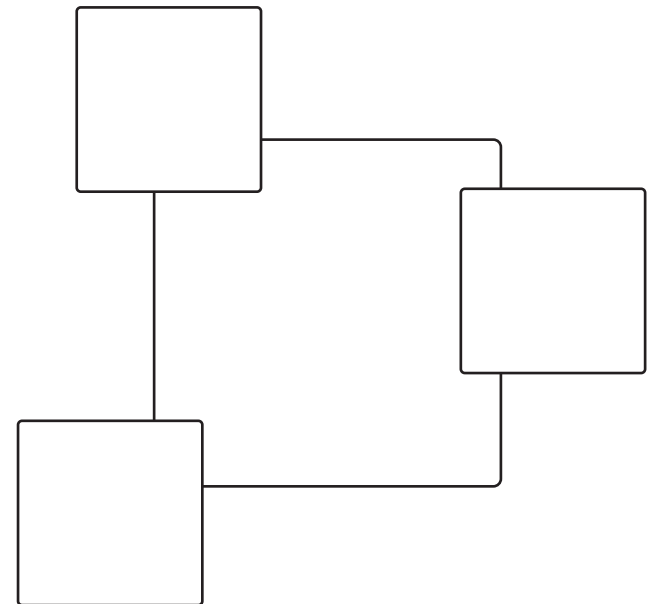

KNEKT Multi-room
Owner's Manual

Copyright and Acknowledgements

Copyright © 2003 Linn Products Ltd. First edition September 2003.

Linn Products Limited, Floors Road, Waterfoot, Glasgow, G76 OEP, Scotland, United Kingdom

All rights reserved. No part of this publication may be reproduced, stored in a retrieval system, or transmitted, in any form or by any means, electronic, mechanical, photocopying, recording, or otherwise, without the prior written permission of the publisher.

Printed in the United Kingdom.

Trade marks used in this publication: **Linn** and the **Linn logo** are registered trade marks of Linn Products Limited. **KNEKT, BASIK, INTERSEKT, KIVOR, MAJIK** and **WAKONDA** are trade marks of Linn Products Limited.

The information in this manual is furnished for informational use only, is subject to change without notice, and should not be construed as a commitment by Linn Products Limited. Linn Products Limited assumes no responsibility or liability for any errors or inaccuracies that may appear in this manual.

Linn Products Limited disclaims any proprietary interest in trade marks and trade names other than its own.

Contents

Your KNEKT Multi-room System

How KNEKT works

Technical Details

Controlling your KNEKT System

KNEKT RCU (Room Control Unit)

KNEKT RCU operation

Overview

Display

Switching the KNEKT RCU on/off

Volume adjustment

Balance adjustment

Tone adjustment

Muting & un-muting

Room selection

Source (CD player, tuner etc) selection

Source product control

KIVOR features

Clock feature

Controlling the KNEKT System by remote control

1	Advanced functions	9
1	Macros	9
2	Alarm function	11
	Sleep Mode	12
2	BASIK 3 IR RCU	13
3	BASIK 3 RCU	13
3	MAJIK or WAKONDA	14
4		
4		
5		
5		
5		
5		
6		
6		
6		
7		
8		
8		

Your KNEKT™ Multi-room System

At Linn, we believe that music is not a luxury, but a necessity. Your KNEKT multi-room system ensures that you achieve the best sound available, distributed throughout your home and easily accessed and controlled at the touch of a button. Your system has been specifically designed and customised to suit your requirements and lifestyle. The sonic performance of the system, combined with its flexibility is certain to enrich your life.

How KNEKT works

Audio is distributed from the hi-fi system, situated in your 'Main' room to a number of 'Secondary' rooms. Each of the Secondary-rooms can listen to, and control the source products (CD player, radio tuner etc) in the Main-room system. A Secondary-room can also have its own local source products, accessible via KNEKT.

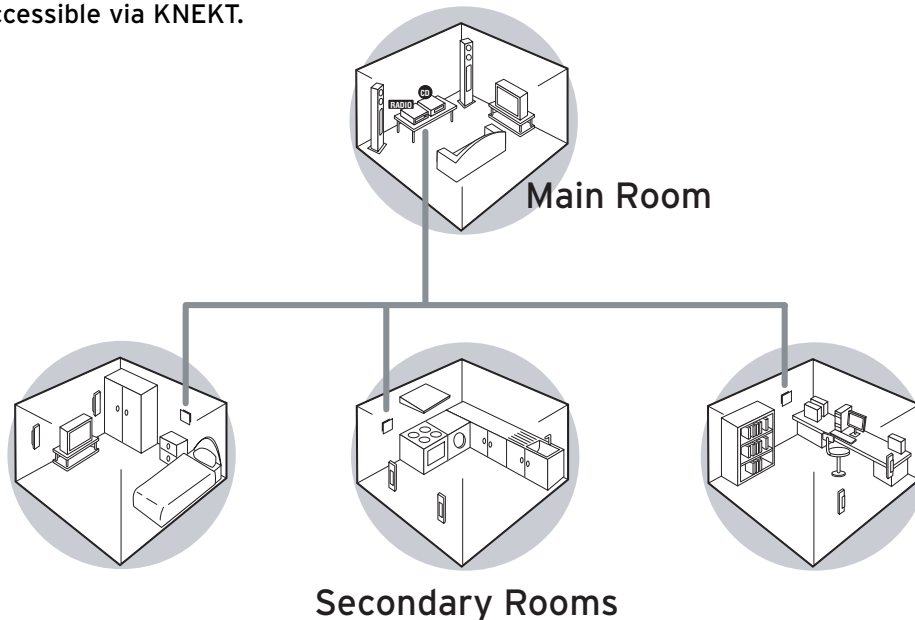

So, for example, your Main-room system (which is perhaps located in your living room) contains a CD player and radio tuner. These sources can be accessed from any Secondary-room - perhaps the kitchen, bathroom and all the bedrooms. The master bedroom, as an example, may also have its own local CD

player and VCR connected to the 'KNEKT Receiver' in that room, and so in addition to the Main-room sources, these 'local' sources can be listened to through the KNEKT system and can be controlled via the KNEKT RCU (Room Control Unit) in that bedroom.

The KNEKT system can be used to control non-Linn source products as well as Linn products and can be fully integrated into a number of home-automation systems, making it very flexible, expandable and future-proof.

KNEKT also has the advantage that sound quality and functionality can be easily upgraded at any time. Consult your Linn Custom Installer for details of upgrade and expansion options.

Technical Details

KNEKT ensures quality sound throughout the home by utilising full volume, line-level, balanced audio distribution.

Line-level transmission

The KNEKT system amplifies the sound locally, which means that the signal is carried from the Main system to the other rooms at line level, rather than loudspeaker level. This makes sure that no drop in quality occurs (loudspeaker-level signals require very expensive and bulky cable and experience significant drop in quality over longer distances). Line-level transmission also makes it possible to feed in local sources, such as television sound, in each room. As well as providing superior sound quality, it means that low-cost, discreet cabling can be used.

Full volume transmission

In the KNEKT multi-room system the audio signals are always distributed at full line level and the volume is controlled at the destination. This optimises the signal-to-noise ratio and improves the dynamic range.

Balanced line

This method of cabling was developed to make sure that source signals maintain their quality even when they have to travel over a long distance. In balanced line wiring, two wires are used to carry the signal - effectively the music signal is inverted (a mirror image is created) and both the inverted and un-inverted signals are carried along separate wires. When the two signals reach their destination, they are re-combined into a single music signal. Any noise that was picked up long the way is eradicated as noise(+) cancels out noise(-), leaving only a clean, high-quality music signal.

Controlling your KNEKT System

Your KNEKT system can be controlled in a number of ways and will utilise one or more of the following control methods:

KNEKT RCU (Room Control Unit)

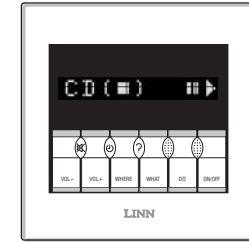

BASIK™ 3 IR RCU



BASIK 3 RCU

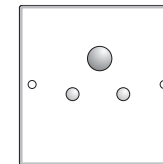

MAJIK™ or WAKONDA™



KNEKT RCU (Room Control Unit)

The KNEKT RCU is a sophisticated, but discreet and stylish control panel. It is, effectively a computer, which is programmed by your Linn Custom Installer to incorporate your system specifications and is customised for your lifestyle. Your Linn Custom Installer can talk you through the various programming options available if they have not already done so. Some very useful options are available - for example, volume can be limited in a specific room; rooms can be programmed to listen to but not control the Main-room system etc.

The KNEKT RCU incorporates a remote control sensor, so all its functions can be controlled from anywhere in the room, via a Linn remote-control handset. Linn source products and (remote controllable) non-Linn source products can also be controlled via the KNEKT system. Your Linn Custom Installer will configure this for you.

KNEKT RCU operation

Overview

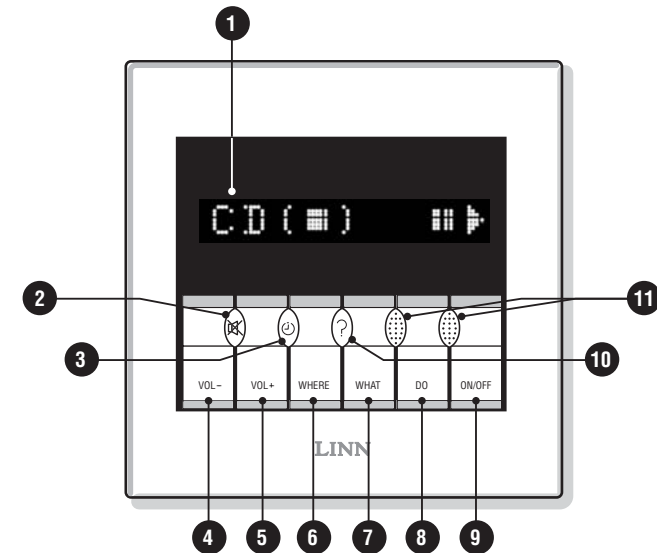

- 1 **Display** Provides feedback and control information for the system.
- 2 **⊗ (mute)** Mutes/un-mutes the sound in the room.
- 3 **🕒 (clock)** Displays the time and/or date.
- 4 **VOL-** } Reduce or increase volume, adjust balance and tone.*
- 5 **VOL+** }
- 6 **WHERE** Selects the room you wish to listen to.
- 7 **WHAT** Selects the source product you wish to listen to.
- 8 **DO** Controls the source product.
- 9 **ON/OFF** Brings the KNEKT RCU in/out of standby mode.
- 10 **?** Provides disc and track information when a KIVOR is used.
- 11 **Multi-function keys** Perform a variety of control tasks - tasks are shown above them on the display.

*Tone controls not available in all systems.

Display

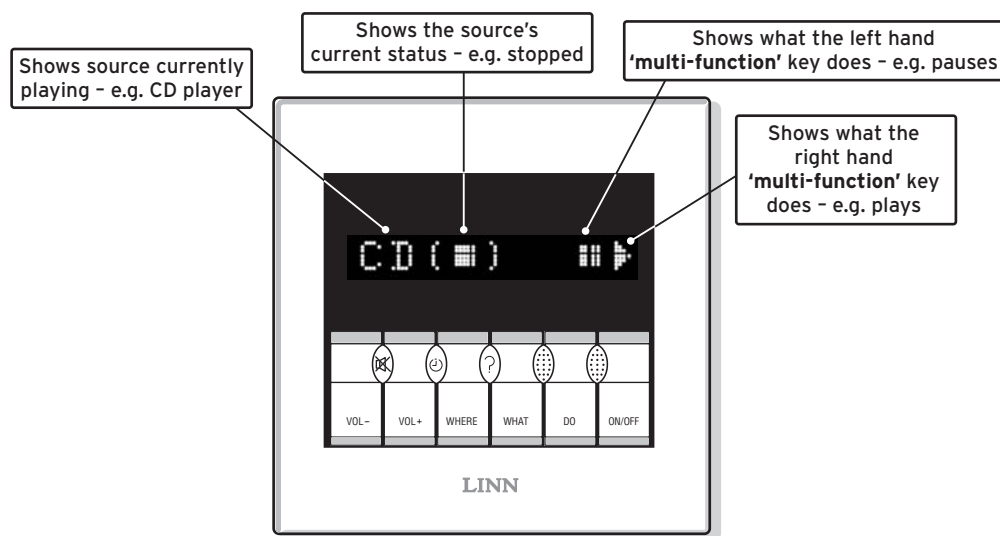

A typical example of the KNEKT RCU display is shown above to illustrate how a source product's controls and current status are displayed (in this case, a CD player). The display will change to reflect the status of the system and what is being controlled at a particular time. What will be displayed is very much dependent on how your system was programmed. Your Linn Custom Installer will be able to help you with any aspects of the programming.

The KNEKT RCU's functions are explained in more detail below.

Switching the KNEKT RCU on/off

To bring a KNEKT RCU in and out of standby:

- Press **ON/OFF** to take the KNEKT RCU in or out of standby.

To switch all the KNEKT RCUs in the system off:

If your KNEKT system is INTERSEKT™ based, you may have the option, depending on how your KNEKT system has been programmed, to send every KNEKT RCU in the system into standby simultaneously (global shutdown):

- Press and hold **ON/OFF** on any KNEKT RCU in the system until the display shows 'off' and starts to count down from 5 - 0. Continue to hold **ON/OFF** until the countdown from 5 - 0 is complete.

Once the countdown is complete, all KNEKT RCUs in the system will then go into standby.

Notes:

Not available in all systems.

Releasing **ON/OFF** before the countdown is complete will not result in a global shutdown and only that KNEKT RCU will go into standby.

To switch KNEKT RCUs on after global shutdown:

- Press **ON/OFF** on each KNEKT RCU that you wish to bring out of standby.

Volume adjustment

To adjust the volume:

- Press **VOL-** or **VOL+** to decrease or increase the volume in the room you are in.

Balance adjustment

To adjust the balance:

- Press **VOL-** and **VOL+** together.

The display shows 'Balance' followed by the current balance setting.

- Press **VOL-** or **VOL+** to shift the balance to the left or right respectively.

The resulting balance position is shown on the display.

Tone adjustment

To adjust the tone:

- Press **VOL-** and **VOL+** together.

The display will firstly show balance. Additional presses of this combination will, if the control product being used contains this function, display bass and treble settings.

- Use **VOL-** or **VOL+** to adjust bass and/or treble.

The resulting tone setting is shown on the display.

Note:

Tone controls are not available in all systems.

Muting & un-muting

To mute and un-mute the system:

- Press  to mute the sound in the room or the zone you are in and press again to restore it to its original volume.

Room selection

To select which room you wish to listen to:

- Press **WHERE**. Repeatedly pressing **WHERE** will step you through the options available. The options available will depend on the room you are in and how your system has been programmed.

Note:

If you select a room, by pressing **WHERE**, but do not select a source product to listen to within that room (by pressing **WHAT**), the KNEKT RCU will time-out after a short delay and will remain set to the original room selection. It is therefore necessary to select the room and the product.

Source (CD player, tuner etc) selection

To select which source product you wish to listen to within a room system:

- Press **WHAT** to select the source product within the room that you wish to listen to. Repeatedly pressing **WHAT** will step you through the options available. The options available will depend on how your system has been programmed.

Source product control

To control the selected source product:

- Press **DO** to select which aspect of the source product you wish to control. Repeatedly pressing **DO** will step you through the options available. The options available will depend on the product in question and how your system has been programmed.

The options will be shown on the right hand side of the display and can be accessed using the 'multi-function' keys as indicated. The function of each 'multi-function' key is shown by the symbol above it on the display. In the example shown below, the left 'multi-function' key would pause the CD player and the right one would play it.

- Press the 'multi-function' key to perform the task shown above it.

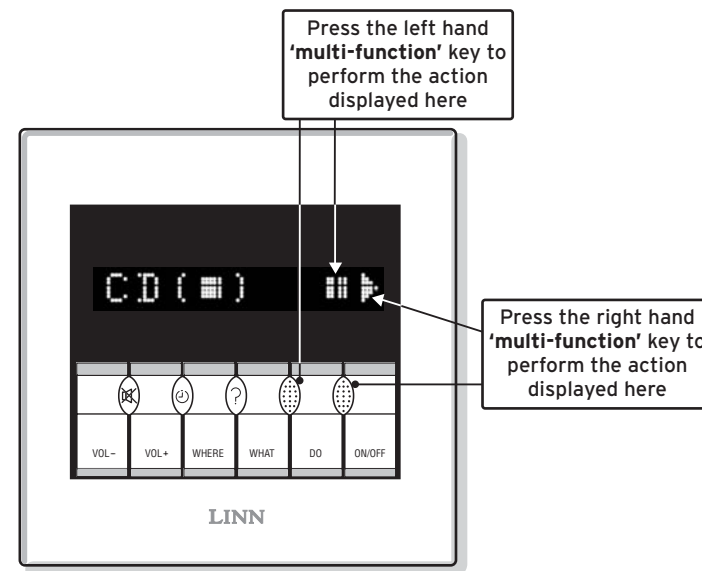

KIVOR™ features

When a KNEKT system contains a KIVOR music archive and retrieval system, some additional features are available, i.e. sub-menus and disc/track information.

To access KIVOR main menu:

- Select the KIVOR, using **WHERE** and **WHAT**, as described in *Source Selection* above.
- Press **DO** to access the KIVOR main menu. Repeatedly pressing **DO** will step you through the options available. The options available will depend on how your system has been programmed.

To access KIVOR sub-menus:

- Press and hold **DO**. After about two seconds, the display will change to show the sub-menu. Repeatedly pressing **DO** will step you through the options available. The options available will depend on how your system has been programmed.

One of the sub-menu options is 'Listmode'. Listmode is a useful method of selecting a disc, artist, track etc from your KIVOR. Listmode is indicated by the '<' and '>' symbols appearing on the display above the '**multi-function**' keys.

- Repeatedly press one of the '**multi-function**' keys to step through the available lists (typically options like Artist, Genre, Disc and User will be available).
- Use **DO** to select a list from the Listmode menu.

The item that you have selected from Listmode will now be available in the KIVOR main menu. The Listmode option that is available in the KIVOR main menu can be changed by repeating the above process.

Note:

The Listmode option that is available in the KIVOR main menu will appear on the display in the sub-menu, but will not be selectable.

To exit from the KIVOR sub-menu

- Press and hold **DO**.
- or
- Press **WHAT**.

This will take you back to the KIVOR main menu.

To access KIVOR disc/track information

- Access the KIVOR, using **WHERE** and **WHAT**, as described above.
- Select a disc and a track, using the **DO** and '**multi-function**' keys.
- Press **?** to access information about the disc and track - i.e. CD title, track title and music genre (where applicable).

Clock feature

To display the clock:

- Press  repeatedly to step you through the clock display options available - i.e. time with seconds; time without seconds; date; day and time.

To set the clock:

- Press , and then  and **DO** simultaneously.

The display shows the current time, with the hours flashing.

- Use the '**multi-function**' keys to change the value of the flashing number, or **DO** to select the next time or date field.
- When you have set the required time and date, press  to store the new values and start the clock. Pressing any other key cancels the changes you have made, and restores the original time and date.

Note:

When the time is updated, any alarm settings stored in the KNEKT RCU (see the *Alarm Function* section later in this manual) will be cancelled.

To perform a system clock update (INTERSEKT based systems only):

If your KNEKT system incorporates the INTERSEKT, at the end of the above sequence the following display will appear:

'System time update?'

And the 'X'  options will appear above the '**multi-function**' keys.

- Press the right hand '**multi-function**' key (below the ), to update all KNEKT RCU clocks in the system.

OR

- Press the left-hand '**multi-function**' key (below the 'X'), to update only the KNEKT RCU in that room.

Controlling the KNEKT system by remote control

If you have a Linn remote control handset that includes the **WHERE, WHAT, DO** and '**multi-function**' keys, then this can be used to control the KNEKT RCU. Use these keys exactly as you would use the equivalent keys on the KNEKT RCU (see *KNEKT RCU operation*, above).

The KNEKT RCU's standard preamplifier functions (volume +/-, mute, balance etc) can also be controlled, using the corresponding keys on the handset.

Note:

If your KNEKT RCU does not respond to the KNEKT commands from the remote control, please check firstly that the remote control handset is functioning (perhaps check it using another Linn product). If the handset is functioning but will not control the KNEKT RCU, it may be that the KNEKT RCU has been programmed so that its remote control sensor is disabled. Please consult your Linn Custom Installer.

Advanced functions

Macros

A very convenient and powerful feature built into the KNEKT RCU is the ability to record a sequence of commands and replay them at a later time. This is known as a macro. For example, you could record a command sequence to select the radio, choose your favourite radio station, and set the volume to 20. You can record up to five different macros, each one containing up to ten commands, for your most frequently-used operations.

To access macro mode:

- Press the **WHERE** and **ON/OFF** keys together so that the display shows 'Macro'. Alternatively, you may have chosen to have Macro mode directly available from the **WHERE** key, in which case you can select it by pressing **WHERE** (this is a programming option - consult your Linn Custom Installer).
- Select the number of the macro you want to use by pressing **WHAT**.

You can have up to five macros, called Macro1 to Macro5.

- Press **DO** to step between the four macro functions:

Replay -	Replay a macro you recorded.
Record -	Record a new macro.
Key - ->	Set up a macro so you can run it from a key.
Erase -	Remove a macro.

To record a macro:

- Access macro mode, following the instructions above (*To access macro mode*) and select the 'Record' option.
- Press the right-hand '**multi-function**' key, under the ► symbol. The display will show 'Start'.

Any keys you now press until you stop recording will be recorded in the macro as well as performing their usual functions. Up to ten commands can be recorded in a macro.

Example.

You may wish to record a macro, which selects the Main-room tuner, selects preset 5 and plays at a low volume (e.g. for morning listening) :

Start the recording process as described above
 Press **WHERE** to select the Main-room system
 Press **WHAT** to select tuner player
 Press **DO** to select the preset function
 Press the right hand '**multi-function**' key repeatedly to select preset 5
 Press **VOL-** to set a volume level of 20

To stop recording the macro:

- Press the **WHERE** and **ON/OFF** keys together to select Macro mode.
- Press the right-hand '**multi-function**' key under the ■ symbol to stop recording.

The display will then show 'Macro Complete' followed by the number of the macro you recorded.

Note:

Each macro can remember up to ten operations. You will be advised if you are getting near this limit while recording a macro - the message 'Remaining steps 2' will be scrolled across the display.

To replay a macro:

- To access macro mode, following the instructions above (*To access macro mode*).
- Press **WHAT** to select the number of the macro you want to replay.
- Press **DO** until the display shows 'Replay'.
- Press the '**multi-function**' key under the ► symbol to replay the macro.

To attach a macro to a key:

You can attach a macro to any of the following keys: **VOL-**, **VOL+**, **⌘**, **ON/OFF** & **🕒** (a clock macro will operate as an alarm - as explained in more detail in *Alarm function* below).

You can then run the macro simply by selecting macro mode and pressing the appropriate key.

- Access macro mode, following instructions (*To access macro mode*) above.
- Press **WHAT** to select the number of the macro you want to attach.
- Press **DO** until the display shows 'Key'.

If the macro is already attached to a key, the display will show the name of the key the macro is attached to.

- To attach a macro to a key, keep pressing the right-hand '**multi-function**' key, under the '>' symbol to step through the available options: **VOL-**, **VOL+**, **⌘**, **ON/OFF**, **🕒**.
- Press **DO** when the correct key is selected.

To detach a macro from a key:

- Follow the instructions above - *To attach a macro to a key*, except in the second last step, press the left-hand '**multi-function**' key (below the '—' symbol), repeatedly to step through the key options.
- Press **DO** once the correct key is selected.

To replay a macro attached to a key:

- If the macro is attached to **VOL-**, **VOL+** or **⌘**, replay it by accessing macro mode and then pressing the relevant key.
- If the macro is attached to **ON/OFF** you can replay it simply by pressing **ON/OFF**.

For information about macros attached to **🕒**, see *Alarm function* below.

To erase a macro:

- Access macro mode, and then press **WHAT** to select the number of the macro you wish to erase.
- Repeatedly press **DO** until the display shows 'Erase'.
- Press the right-hand '**multi-function**' key under the ► symbol to erase the macro.

Alarm function

The KNEKT RCU contains a very flexible alarm function, which can activate a macro (see *Macros above*) at a specific time, or series of times of your choosing. This function will therefore switch on the KNEKT RCU as specified and play a selected source. So, for example it could be used to wake you up in the morning to the sound of your favourite radio station or your favourite CD track.

To set an alarm:

- Access macro mode, by pressing the **WHERE** and **ON/OFF** keys together.
- Press **WHAT** to select the number of the macro you have recorded that you wish to use for the alarm.
- Press **DO** until the display shows 'Key'.
- Press .

After a short delay the display will show 'Alarm1'.

- If you are already using Alarm1, or wish to select another Alarm number, press **WHAT** to choose an alternative.
- Press **DO** to show the type of alarm; you have the following choices:

Daily:	The macro will be played every day, at the same time
Wkday:	The macro will be played only on selected weekdays. Numbers 1-7 correspond with Sunday to Saturday respectively. Large numbers mean that alarm is inactive that day. Small numbers mean alarm is active
Dated:	The macro will be played only on a specific date.

- Press the '**multi-function**' key under the ◀ or ▶ symbol to step through the different types of alarm and press **DO** to select.

- Press the '**multi-function**' keys to change the flashing number.
- Press **DO** to move to the next number.
- Once you have finished setting the alarm, press  to store your setting.

To modify an alarm:

- To modify an alarm, (for example, to change the time), proceed as for *To set an alarm* above, and select the number of the macro and the number of the alarm you have already defined.
- Step through the fields you have defined using **DO** until you get to the one you wish to change.
- Use the '**multi-function**' keys to change the flashing number.
- Press  to store the modified alarm.

To cancel an alarm:

- Detach the macro associated with the alarm from the  key (see *To detach a macro from a key*).

Sleep Mode

Sleep mode shuts the system down after a designated time period. You may, for example wish to listen to music in bed but would like the system to automatically switch off so that the music is not playing for too long after you fall asleep.

To set the KNEKT RCU sleep mode:



- Press  and **ON/OFF** simultaneously.

The display will show 'Sleep mode', followed by 'Where?'

- Press **WHERE** to select which system you wish to shut-down - i.e. the local system only, the Main-room system or the entire system.

Note:

All the above options may not be available. The options available will depend on the room you are in and how your system has been specified and programmed.

- Press  to select the time period. Repeatedly pressing  will step you through the time options available.
- Press **DO** to confirm your settings.

The display will show a small clock symbol and will show the time remaining until shutdown. This time will count down.

Note:

Volume can be controlled while the KNEKT RCU is in sleep mode, however no other functions are accessible unless sleep mode is cancelled.

To cancel sleep mode:

- Press any key on the KNEKT RCU, other than , **VOL-** or **VOL+**.

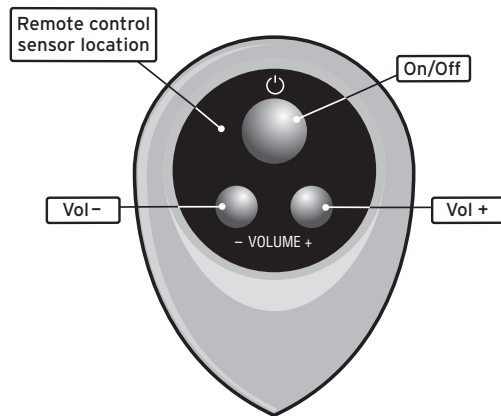
BASIK 3 IR RCU

- Use the keys to control volume or switch the system on/off for the room or sub-zone* in which the BASIK 3 IR RCU is operating.
- Use a Linn remote control to control the above functions and also to control a source product that is being listened to in that room or sub-zone.

Example:

A CD player could be stopped, paused, skipped etc using the CD control keys on the remote control handset.

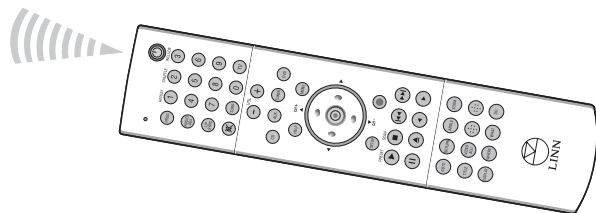
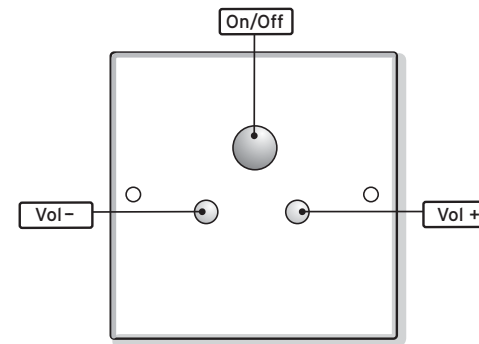
**BASIK 3 RCU**

- Use the keys to control volume or switch the system on/off for the room or sub-zone* in which the BASIK 3 RCU is operating.

* A Sub-zone is an area adjacent to a Secondary-room, which shares that Secondary-room system. Sub-zones are not available in all systems - consult your Linn Custom Installer, who can talk you through the options available.

MAJIK or WAKONDA

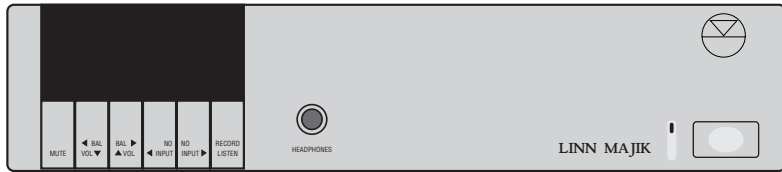

A MAJIK or WAKONDA control amplifier in a Secondary-room that is fitted with a Sneaky Receiver module can be used to select and control the Main-room system, without any other control product being used.

To select the Main-room system:

- Repeatedly press **INPUT+** or **INPUT-** on the MAJIK or WAKONDA.

The display will show each of the local inputs in turn, and also 'dA' (Distributed Audio), which allows you to listen to music from the Main-room system.

- Alternatively, use **WHERE** on the remote handset (if available) for direct selection of dA.

To control the Main-room system:

- Access the Main-room system, following instructions above.
- Use **WHAT** to step through the source products in the Main-room system, listening to each in turn (the display will not identify which one is selected).
- Control the source product using the appropriate group of keys on the remote control handset for that source product - e.g. a CD player could be stopped, paused, skipped etc using the CD control keys on the remote control handset.

Note:

This operation is not possible without a Linn remote-control handset, or a programmed remote control, containing the **WHAT** key.

